

Interlocking Tile Details

FLRP-1 - Eave Detail

FLRP-2 - Built-In Gutter Detail

FLRP-3a - Ridge / Hip Detail - Opt. 1

FLRP-3b - Ridge / Hip Detail - Opt. 2

FLRP-4a - Mono-Pitch Ridge Detail - Opt. 1

FLRP-4b - Mono-Pitch Ridge Detail - Opt. 2

FLRP-5a - Valley Detail - Opt. 1

FLRP-5b - Valley Detail - Opt. 2

FLRP-6 - Rake Edge Detail

FLRP-7 - Cross Joint Detail

FLRP-8 - Roof to Wall Transition Detail

FLRP-9 - Sidewall Detail

FLRP-10 - Skylight Sill Detail

FLRP-11 - Skylight Head Detail

FLRP-12 - Skylight Jamb Detail

FLRP-13 - Vent Pipe Penetration Detail

FLRP-14 - Diamond Fab. Detail

FLRP-15a - Rect. Fab. Detail - Horizontal

FLRP-15b - Rect. Fab. Detail - Vertical

FLRP-15c - Rect. Fab. Detail - H Folded

FLRP-15d - Rect. Fab. Detail - V Folded

FLRP-16 - Square Fab. Detail

FLAT LOCK PANEL ROOF DETAILS

- DIAMOND
- RECTANGULAR
- SQUARE

INDEX OF DRAWINGS

- FLRP-1 - EAVE DETAIL
- FLRP-2 - BUILT-IN GUTTER DETAIL
- FLRP-3A - RIDGE / HIP DETAIL - OPTION 1
- FLRP-3B - RIDGE / HIP DETAIL - OPTION 2
- FLRP-4A - MONO-PITCH RIDGE DETAIL - OPTION 1
- FLRP-4B - MONO-PITCH RIDGE DETAIL - OPTION 2
- FLRP-5A - VALLEY DETAIL - OPTION 1
- FLRP-5B - VALLEY DETAIL - OPTION 2
- FLRP-6 - RAKE EDGE DETAIL
- FLRP-7 - CROSS JOINT DETAIL
- FLRP-8 - ROOF TO WALL TRANSITION DETAIL
- FLRP-9 - SIDEWALL DETAIL
- FLRP-10 - SKYLIGHT SILL DETAIL
- FLRP-11 - SKYLIGHT HEAD DETAIL
- FLRP-12 - SKYLIGHT JAMB DETAIL
- FLRP-13 - VENT PIPE PENETRATION DETAIL
- FLRP-14 - DIAMOND FABRICATION DETAIL
- FLRP-15A - RECTANGULAR FABRICATION DETAIL - HORIZONTAL
- FLRP-15B - RECTANGULAR FABRICATION DETAIL - VERTICAL
- FLRP-15C - RECTANGULAR FABRICATION DETAIL - HORIZONTAL FOLDED
- FLRP-15D - RECTANGULAR FABRICATION DETAIL - VERTICAL FOLDED
- FLRP-16 - SQUARE FABRICATION DETAIL

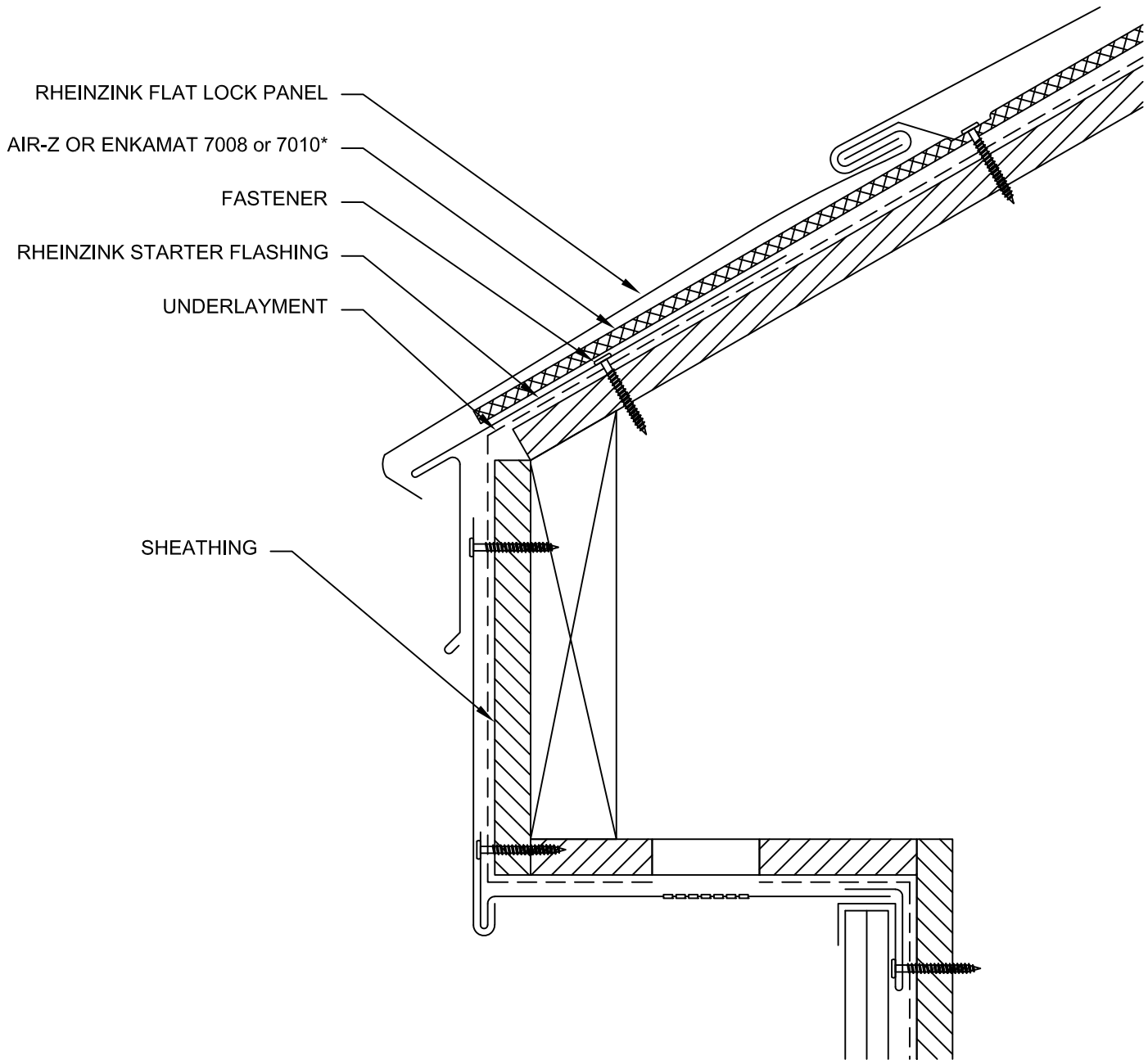

* CLIP DETAIL

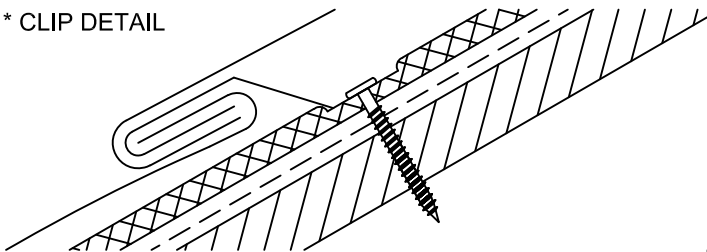

NOTES:

1. RHEINZINK RECOMMENDS STAINLESS STEEL FASTENERS AND CLIPS.
2. FLAT LOCK PANELS REQUIRE A MINIMUM OF 3:12 PITCH. FLAT LOCK PANEL ROOF SYSTEMS UP TO 6 IN 12 REQUIRE BOTH PROROOING AND AIR-Z OR ENKAMAT (7008/7010) FLAT LOCK PANELS OVER A 6 IN 12 PITCH REQUIRE AIR-Z OR ENKAMAT (7008/7010) OR PROROOING.

		
96F Commerce Way Woburn, MA 01801 T: 781.729.0812 Website: www.rheinzink.us E-mail: info@rheinzink.com		
INFORMATION AND DETAILS HEREIN ARE ONLY A BASELINE FOR SYSTEM DESIGN AND INSTALLATION. MODIFICATION TO MEET PROJECT REQUIREMENTS IS THE RESPONSIBILITY OF THE DESIGNER AND ARCHITECT. RHEINZINK AMERICA STAFF ARE AVAILABLE TO ASSIST THE DESIGNER AND ARCHITECT IN THIS PROCESS. RHEINZINK AMERICA MAKES NO REPRESENTATIONS AND WARRANTIES OTHER THAN THOSE EXPRESSED HEREIN.		
PROJECT:	FLAT LOCK ROOF PANEL DETAILS	DATE: 5-2020
DRAWING TITLE:	EAVE DETAIL	SCALE: N.T.S.
COPYRIGHT RESERVED. THIS DRAWING REMAINS THE PROPERTY OF RHEINZINK.		SHEET: FLRP-1

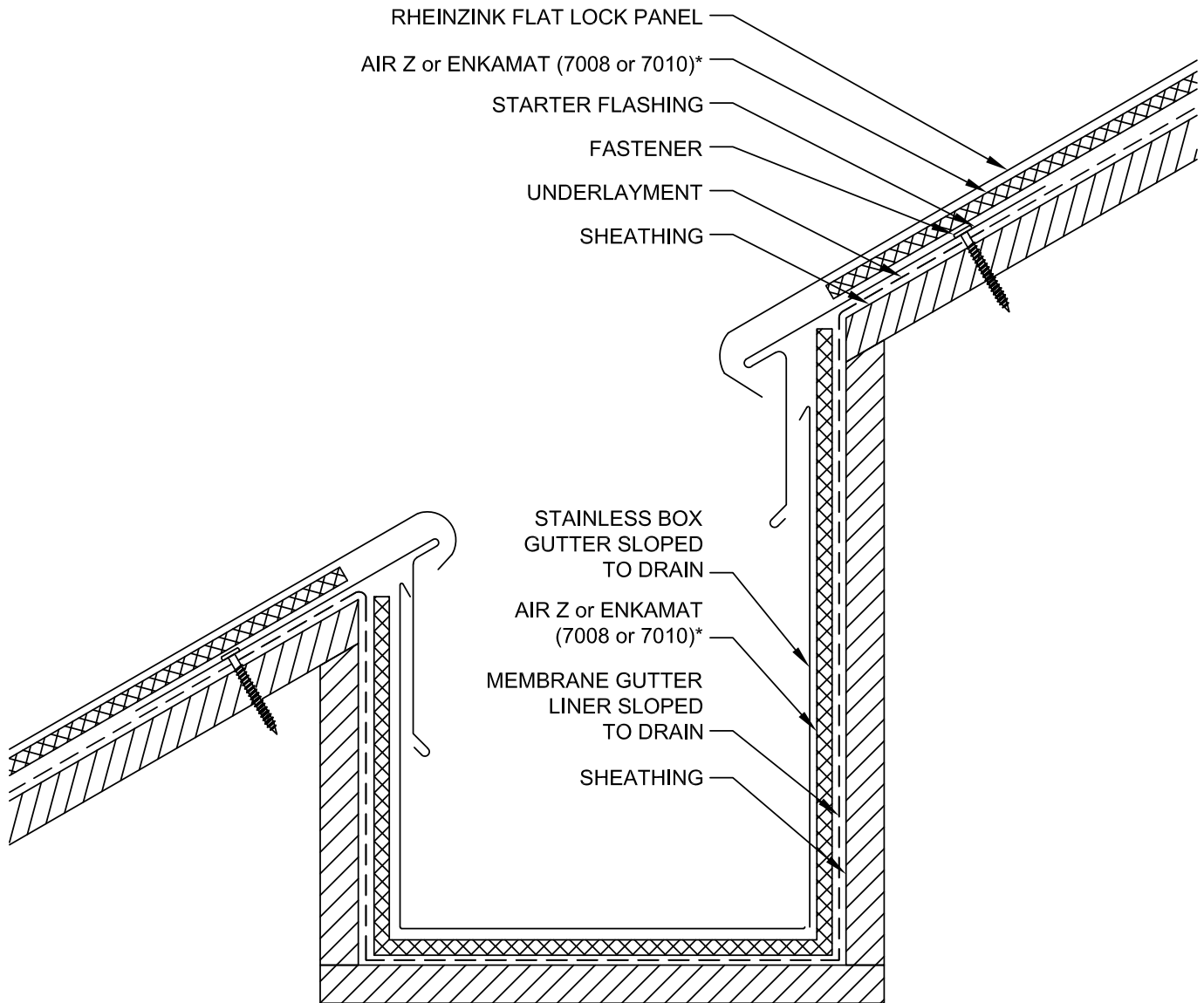

* CLIP DETAIL

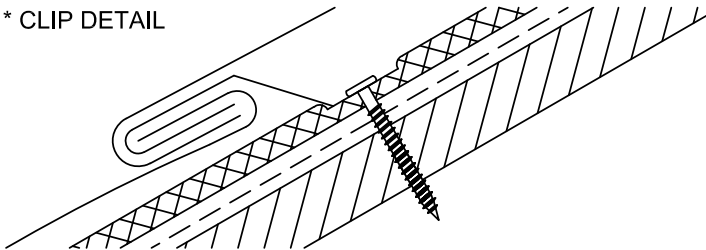

NOTES:

1. RHEINZINK RECOMMENDS STAINLESS STEEL FASTENERS AND CLIPS.
2. FLAT LOCK PANELS REQUIRE A MINIMUM OF 3:12 PITCH. FLAT LOCK PANEL ROOF SYSTEMS UP TO 6 IN 12 REQUIRE BOTH PROROOING AND AIR-Z OR ENKAMAT (7008/7010) FLAT LOCK PANELS OVER A 6 IN 12 PITCH REQUIRE AIR-Z OR ENKAMAT (7008/7010) OR PROROOING.

	
96F Commerce Way Woburn, MA 01801 T: 781.729.0812 Website: www.rheinznk.us E-mail: info@rheinznk.com	
INFORMATION AND DETAILS HEREIN ARE ONLY A BASELINE FOR SYSTEM DESIGN AND INSTALLATION. MODIFICATION TO MEET PROJECT REQUIREMENTS IS THE RESPONSIBILITY OF THE DESIGNER AND ARCHITECT. RHEINZINK AMERICA STAFF ARE AVAILABLE TO ASSIST THE DESIGNER AND ARCHITECT IN THIS PROCESS. RHEINZINK AMERICA MAKES NO REPRESENTATIONS AND WARRANTIES OTHER THAN THOSE EXPRESSED HEREIN.	
PROJECT:	DATE:
FLAT LOCK ROOF PANEL DETAILS	5-2020
DRAWING TITLE:	SCALE:
BUILT-IN GUTTER DETAIL	N.T.S.
COPYRIGHT RESERVED. THIS DRAWING REMAINS THE PROPERTY OF RHEINZINK.	SHEET:
	FLRP-2

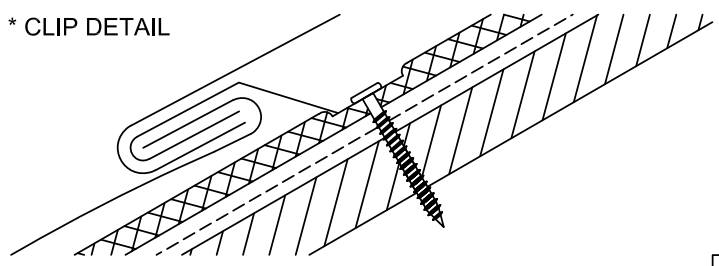
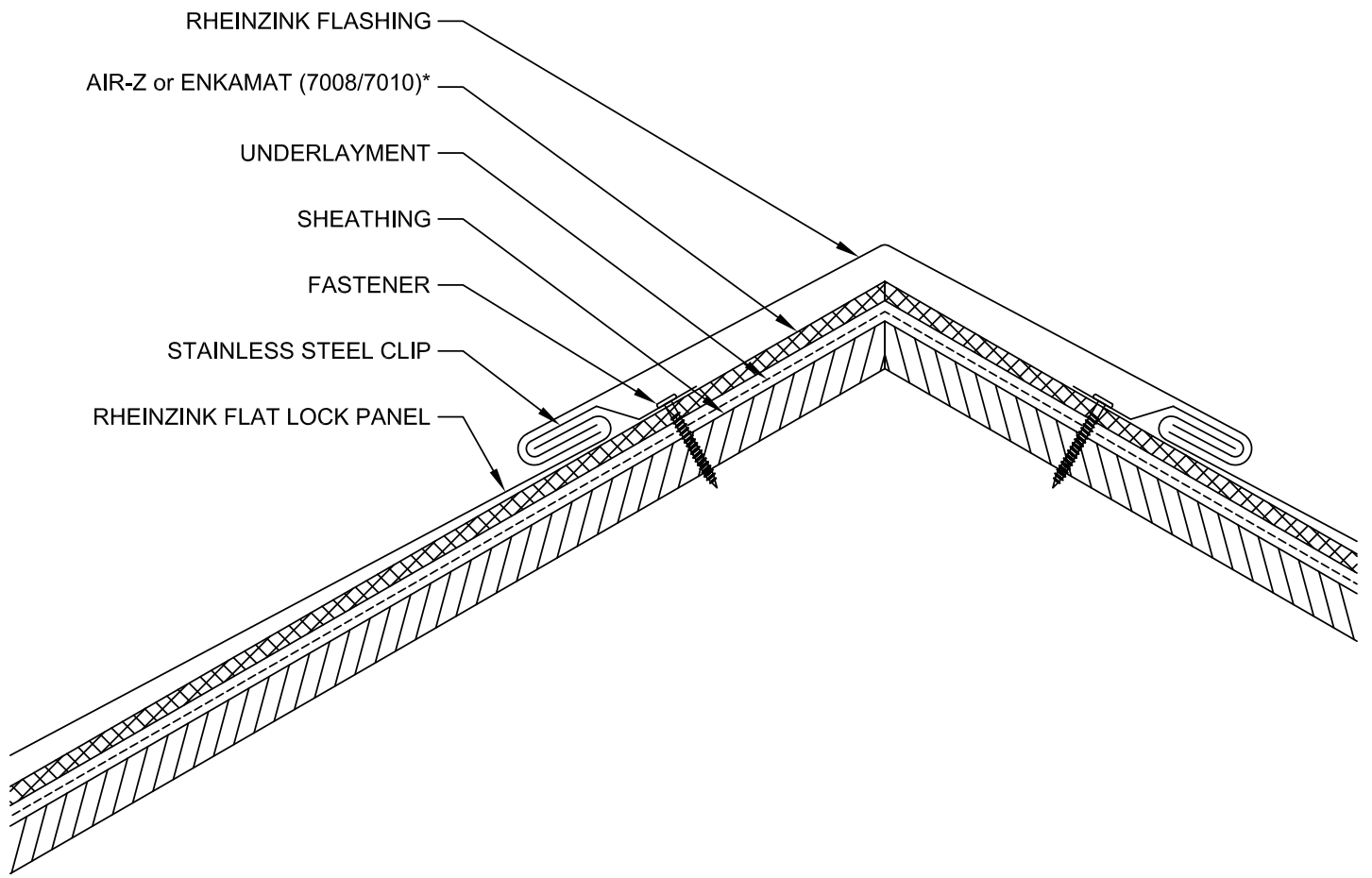

- NOTES:**
1. RHEINZINK RECOMMENDS STAINLESS STEEL FASTENERS AND CLIPS.
 2. FLAT LOCK PANELS REQUIRE A MINIMUM OF 3:12 PITCH. FLAT LOCK PANEL ROOF SYSTEMS UP TO 6 IN 12 REQUIRE BOTH PROROOING AND AIR-Z OR ENKAMAT (7008/7010) FLAT LOCK PANELS OVER A 6 IN 12 PITCH REQUIRE AIR-Z OR ENKAMAT (7008/7010) OR PROROOING.

 96F Commerce Way Woburn, MA 01801 T: 781.729.0812 Website: www.rheinzink.us E-mail: info@rheinzink.com			
INFORMATION AND DETAILS HEREIN ARE ONLY A BASELINE FOR SYSTEM DESIGN AND INSTALLATION. MODIFICATION TO MEET PROJECT REQUIREMENTS IS THE RESPONSIBILITY OF THE DESIGNER AND ARCHITECT. RHEINZINK AMERICA STAFF ARE AVAILABLE TO ASSIST THE DESIGNER AND ARCHITECT IN THIS PROCESS. RHEINZINK AMERICA MAKES NO REPRESENTATIONS AND WARRANTIES OTHER THAN THOSE EXPRESSED HEREIN.			
PROJECT:	FLAT LOCK ROOF PANEL DETAILS	DATE:	5-2020
DRAWING TITLE:	RIDGE / HIP DETAIL - OPTION 1	SCALE:	N.T.S.
COPYRIGHT RESERVED. THIS DRAWING REMAINS THE PROPERTY OF RHEINZINK.		SHEET:	FLRP-3A

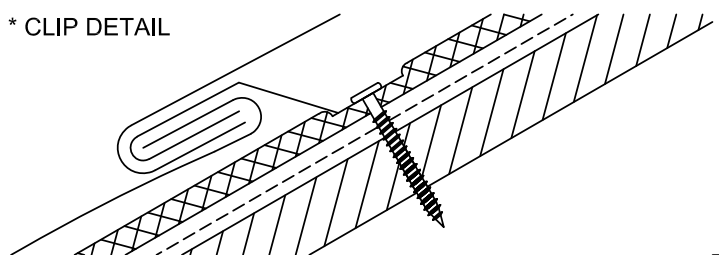
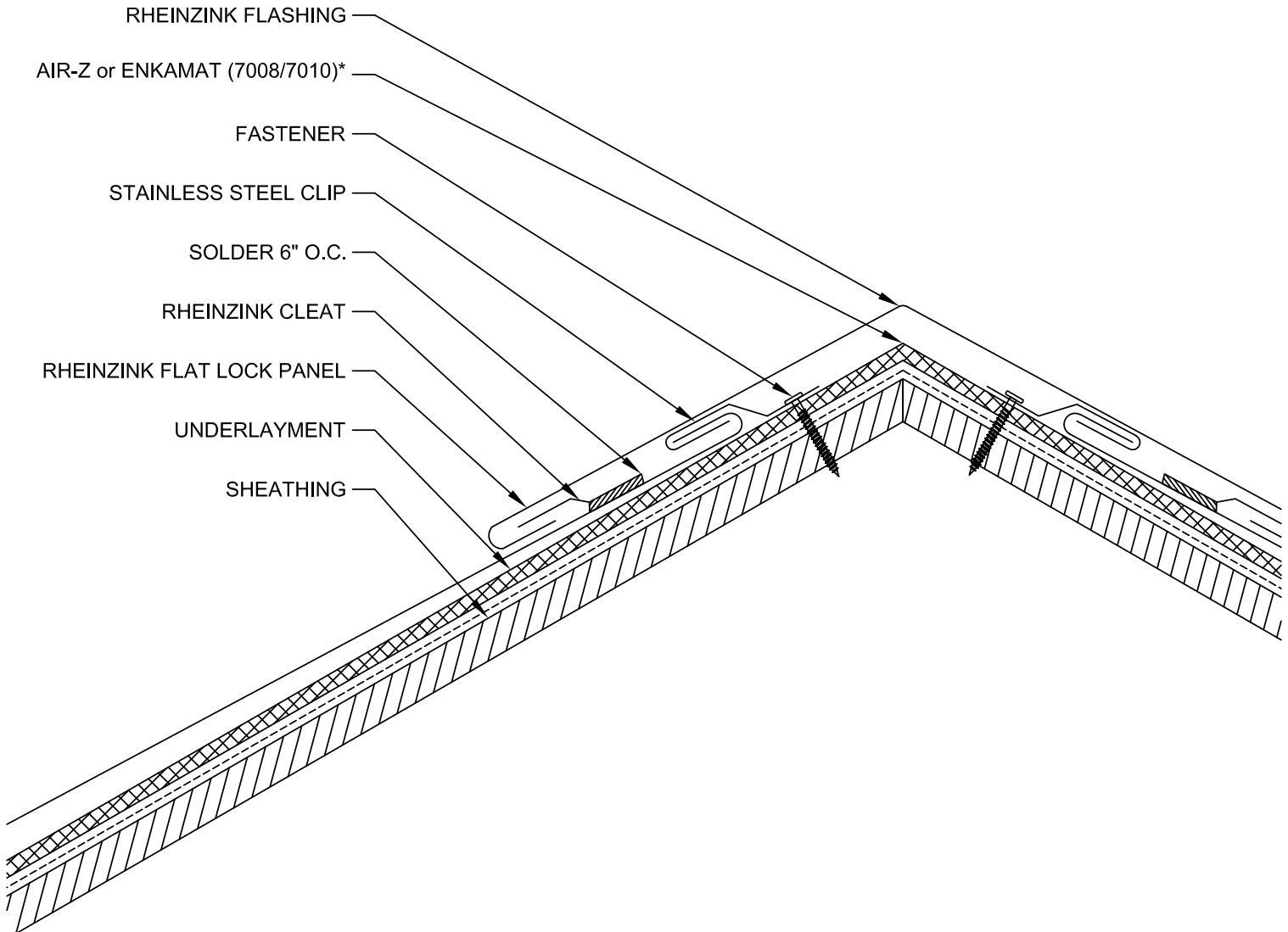

- NOTES:**
1. RHEINZINK RECOMMENDS STAINLESS STEEL FASTENERS AND CLIPS.
 2. FLAT LOCK PANELS REQUIRE A MINIMUM OF 3:12 PITCH. FLAT LOCK PANEL ROOF SYSTEMS UP TO 6 IN 12 REQUIRE BOTH PROROOING AND AIR-Z OR ENKAMAT (7008/7010) FLAT LOCK PANELS OVER A 6 IN 12 PITCH REQUIRE AIR-Z OR ENKAMAT (7008/7010) OR PROROOING.

		
96F Commerce Way Woburn, MA 01801 T: 781.729.0812 Website: www.rheinzink.us E-mail: info@rheinzink.com		
INFORMATION AND DETAILS HEREIN ARE ONLY A BASELINE FOR SYSTEM DESIGN AND INSTALLATION. MODIFICATION TO MEET PROJECT REQUIREMENTS IS THE RESPONSIBILITY OF THE DESIGNER AND ARCHITECT. RHEINZINK AMERICA STAFF ARE AVAILABLE TO ASSIST THE DESIGNER AND ARCHITECT IN THIS PROCESS. RHEINZINK AMERICA MAKES NO REPRESENTATIONS AND WARRANTIES OTHER THAN THOSE EXPRESSED HEREIN.		
PROJECT:	FLAT LOCK ROOF PANEL DETAILS	DATE: 5-2020
DRAWING TITLE:	RIDGE / HIP DETAIL - OPTION 2	SCALE: N.T.S.
COPYRIGHT RESERVED. THIS DRAWING REMAINS THE PROPERTY OF RHEINZINK.		SHEET: FLRP-3B

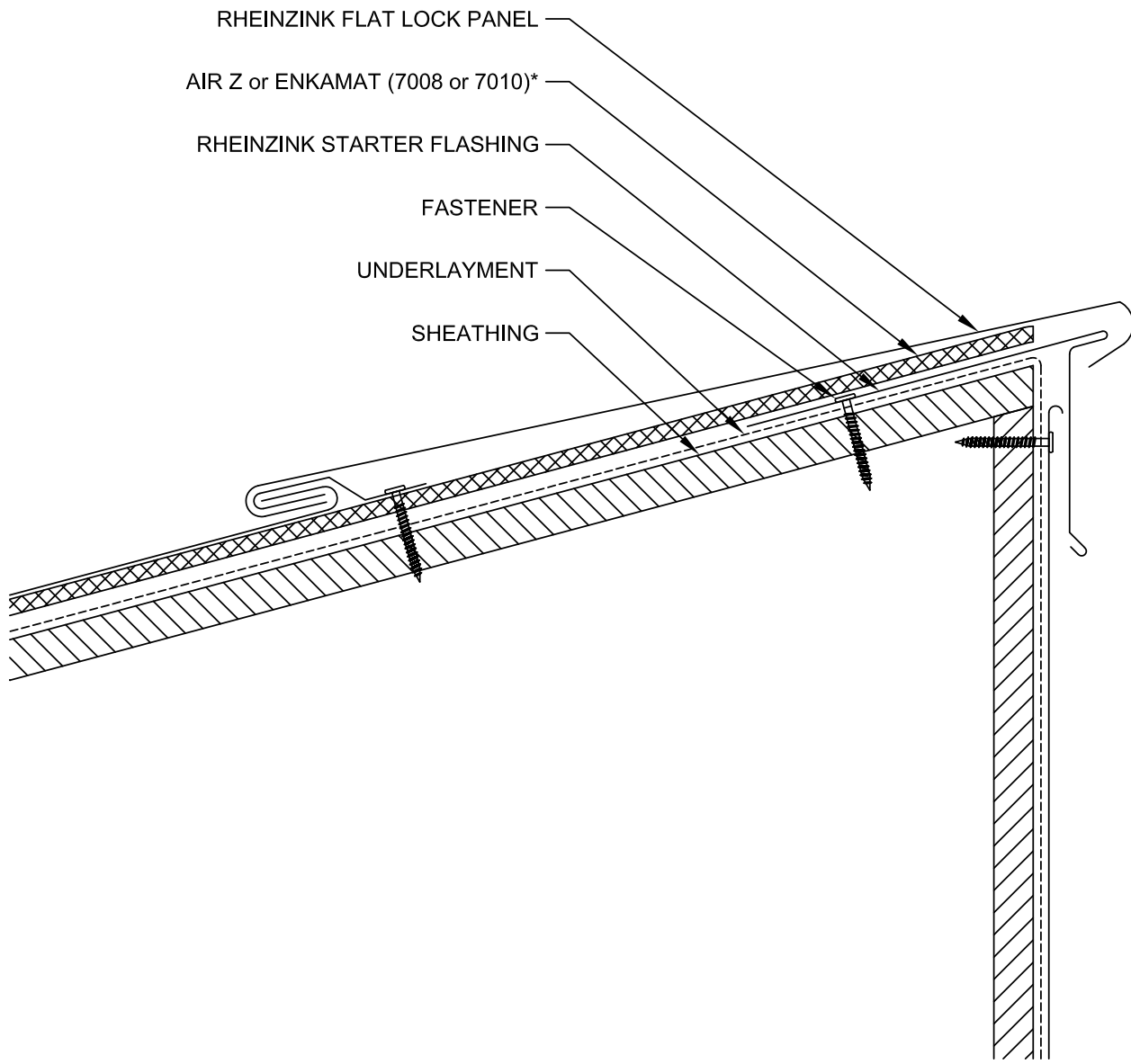

RHEINZINK FLAT LOCK PANEL
 AIR Z or ENKAMAT (7008 or 7010)*
 RHEINZINK STARTER FLASHING
 FASTENER
 UNDERLAYMENT
 SHEATHING

* CLIP DETAIL

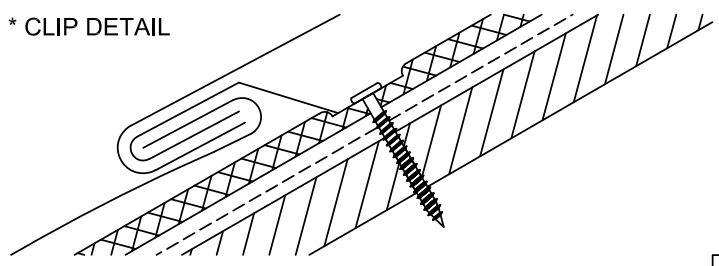

NOTES:

1. RHEINZINK RECOMMENDS STAINLESS STEEL FASTENERS AND CLIPS.
2. FLAT LOCK PANELS REQUIRE A MINIMUM OF 3:12 PITCH. FLAT LOCK PANEL ROOF SYSTEMS UP TO 6 IN 12 REQUIRE BOTH PROROOING AND AIR-Z OR ENKAMAT (7008/7010) FLAT LOCK PANELS OVER A 6 IN 12 PITCH REQUIRE AIR-Z OR ENKAMAT (7008/7010) OR PROROOING.

 96F Commerce Way Woburn, MA 01801 T: 781.729.0812 Website: www.rheinzink.us E-mail: info@rheinzink.com	
INFORMATION AND DETAILS HEREIN ARE ONLY A BASELINE FOR SYSTEM DESIGN AND INSTALLATION. MODIFICATION TO MEET PROJECT REQUIREMENTS IS THE RESPONSIBILITY OF THE DESIGNER AND ARCHITECT. RHEINZINK AMERICA STAFF ARE AVAILABLE TO ASSIST THE DESIGNER AND ARCHITECT IN THIS PROCESS. RHEINZINK AMERICA MAKES NO REPRESENTATIONS AND WARRANTIES OTHER THAN THOSE EXPRESSED HEREIN.	
PROJECT: FLAT LOCK ROOF PANEL DETAILS	DATE: 5-2020
DRAWING TITLE: MONO-PITCH RIDGE DETAIL	SCALE: N.T.S.
COPYRIGHT RESERVED. THIS DRAWING REMAINS THE PROPERTY OF RHEINZINK.	SHEET: FLRP-4

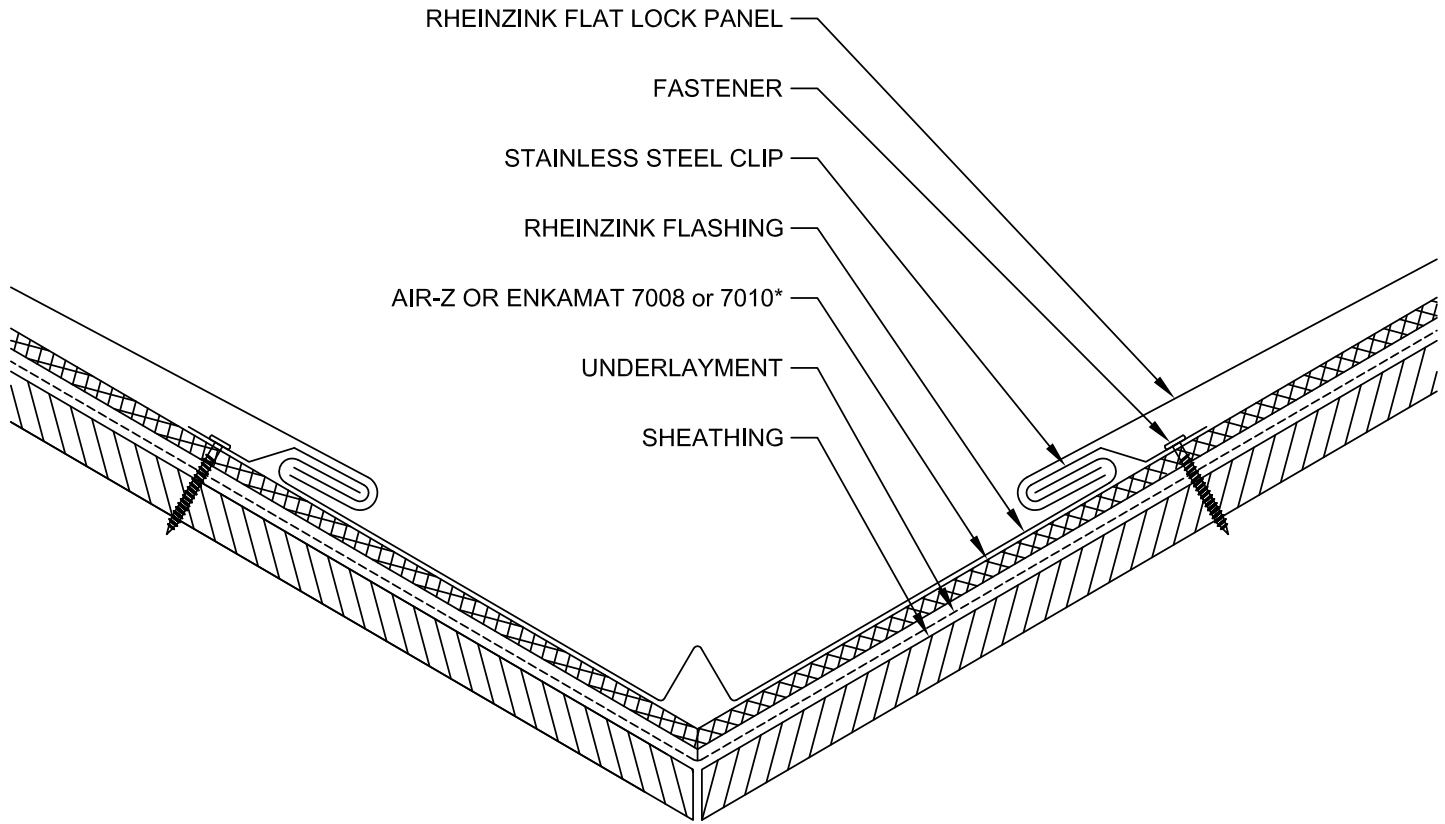

* CLIP DETAIL

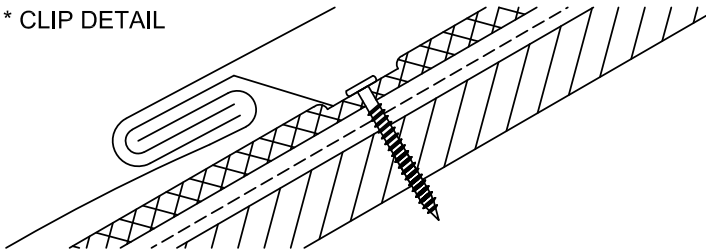

NOTES:

1. RHEINZINK RECOMMENDS STAINLESS STEEL FASTENERS AND CLIPS.
2. FLAT LOCK PANELS REQUIRE A MINIMUM OF 3:12 PITCH. FLAT LOCK PANEL ROOF SYSTEMS UP TO 6 IN 12 REQUIRE BOTH PROROOING AND AIR-Z OR ENKAMAT (7008/7010) FLAT LOCK PANELS OVER A 6 IN 12 PITCH REQUIRE AIR-Z OR ENKAMAT (7008/7010) OR PROROOING.



96F Commerce Way Woburn, MA 01801 T: 781.729.0812
 Website: www.rheinzink.us E-mail: info@rheinzink.com

INFORMATION AND DETAILS HEREIN ARE ONLY A BASELINE FOR SYSTEM DESIGN AND INSTALLATION. MODIFICATION TO MEET PROJECT REQUIREMENTS IS THE RESPONSIBILITY OF THE DESIGNER AND ARCHITECT. RHEINZINK AMERICA STAFF ARE AVAILABLE TO ASSIST THE DESIGNER AND ARCHITECT IN THIS PROCESS. RHEINZINK AMERICA MAKES NO REPRESENTATIONS AND WARRANTIES OTHER THAN THOSE EXPRESSED HEREIN.

PROJECT:	FLAT LOCK ROOF PANEL DETAILS	DATE:	5-2020
DRAWING TITLE:	VALLEY DETAIL - OP 1	SCALE:	N.T.S.
COPYRIGHT RESERVED. THIS DRAWING REMAINS THE PROPERTY OF RHEINZINK.		SHEET:	FLRP-5A

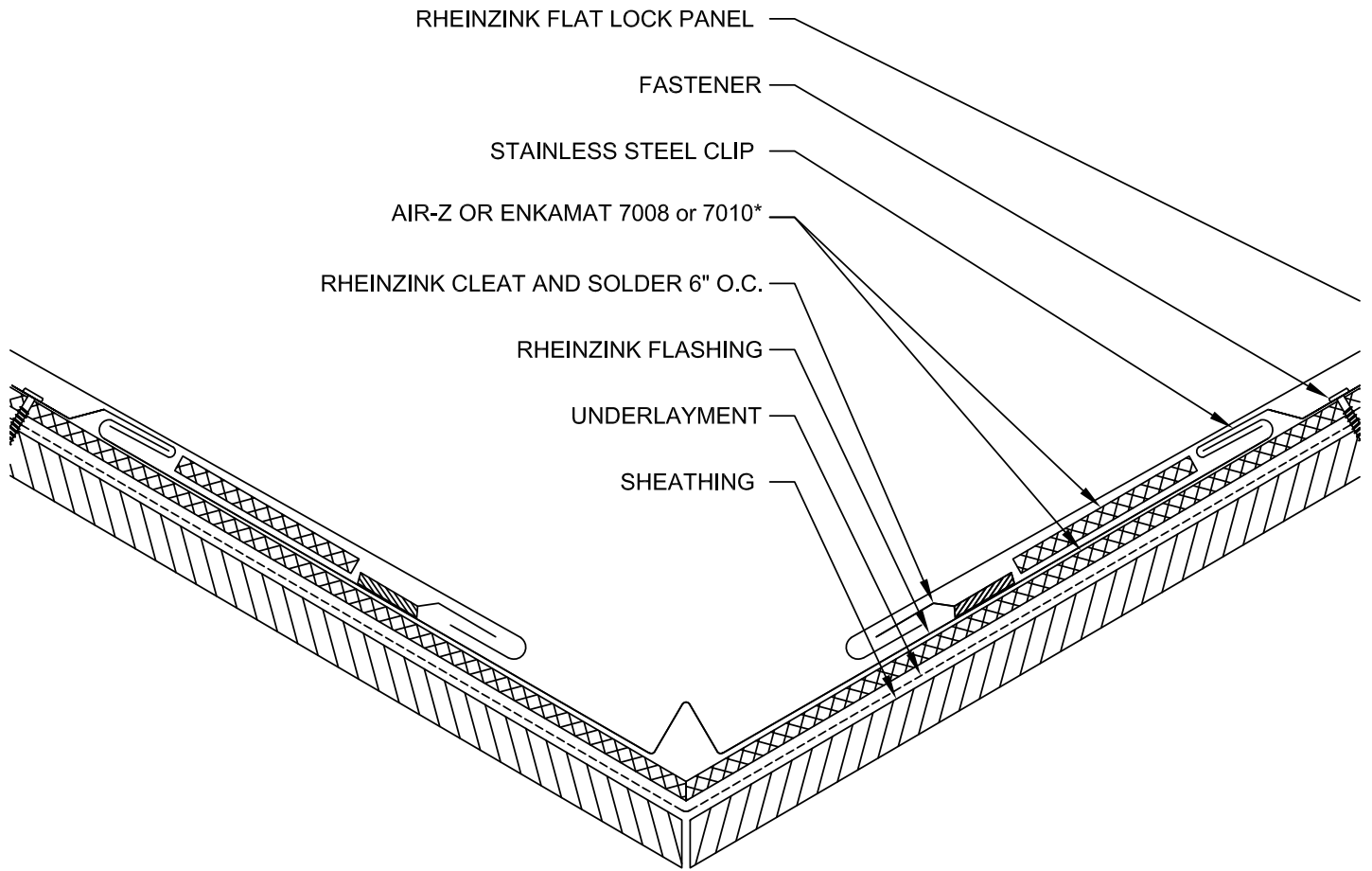

* CLIP DETAIL

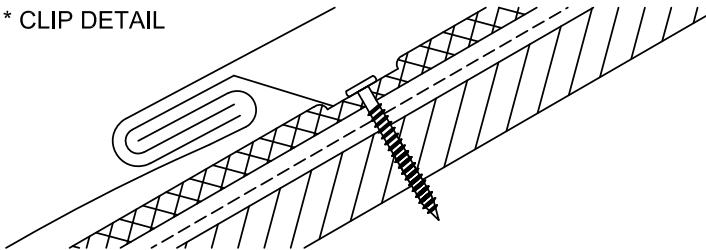

NOTES:

1. RHEINZINK RECOMMENDS STAINLESS STEEL FASTENERS AND CLIPS.
2. FLAT LOCK PANELS REQUIRE A MINIMUM OF 3:12 PITCH. FLAT LOCK PANEL ROOF SYSTEMS UP TO 6 IN 12 REQUIRE BOTH PROROOING AND AIR-Z OR ENKAMAT (7008/7010) FLAT LOCK PANELS OVER A 6 IN 12 PITCH REQUIRE AIR-Z OR ENKAMAT (7008/7010) OR PROROOING.



96F Commerce Way Woburn, MA 01801 T: 781.729.0812
 Website: www.rheinzink.us E-mail: info@rheinzink.com

INFORMATION AND DETAILS HEREIN ARE ONLY A BASELINE FOR SYSTEM DESIGN AND INSTALLATION. MODIFICATION TO MEET PROJECT REQUIREMENTS IS THE RESPONSIBILITY OF THE DESIGNER AND ARCHITECT. RHEINZINK AMERICA STAFF ARE AVAILABLE TO ASSIST THE DESIGNER AND ARCHITECT IN THIS PROCESS. RHEINZINK AMERICA MAKES NO REPRESENTATIONS AND WARRANTIES OTHER THAN THOSE EXPRESSED HEREIN.

PROJECT:	FLAT LOCK ROOF PANEL DETAILS	DATE:	5-2020
DRAWING TITLE:	VALLEY DETAIL - OP 2	SCALE:	N.T.S.
COPYRIGHT RESERVED. THIS DRAWING REMAINS THE PROPERTY OF RHEINZINK.		SHEET:	FLRP-5B

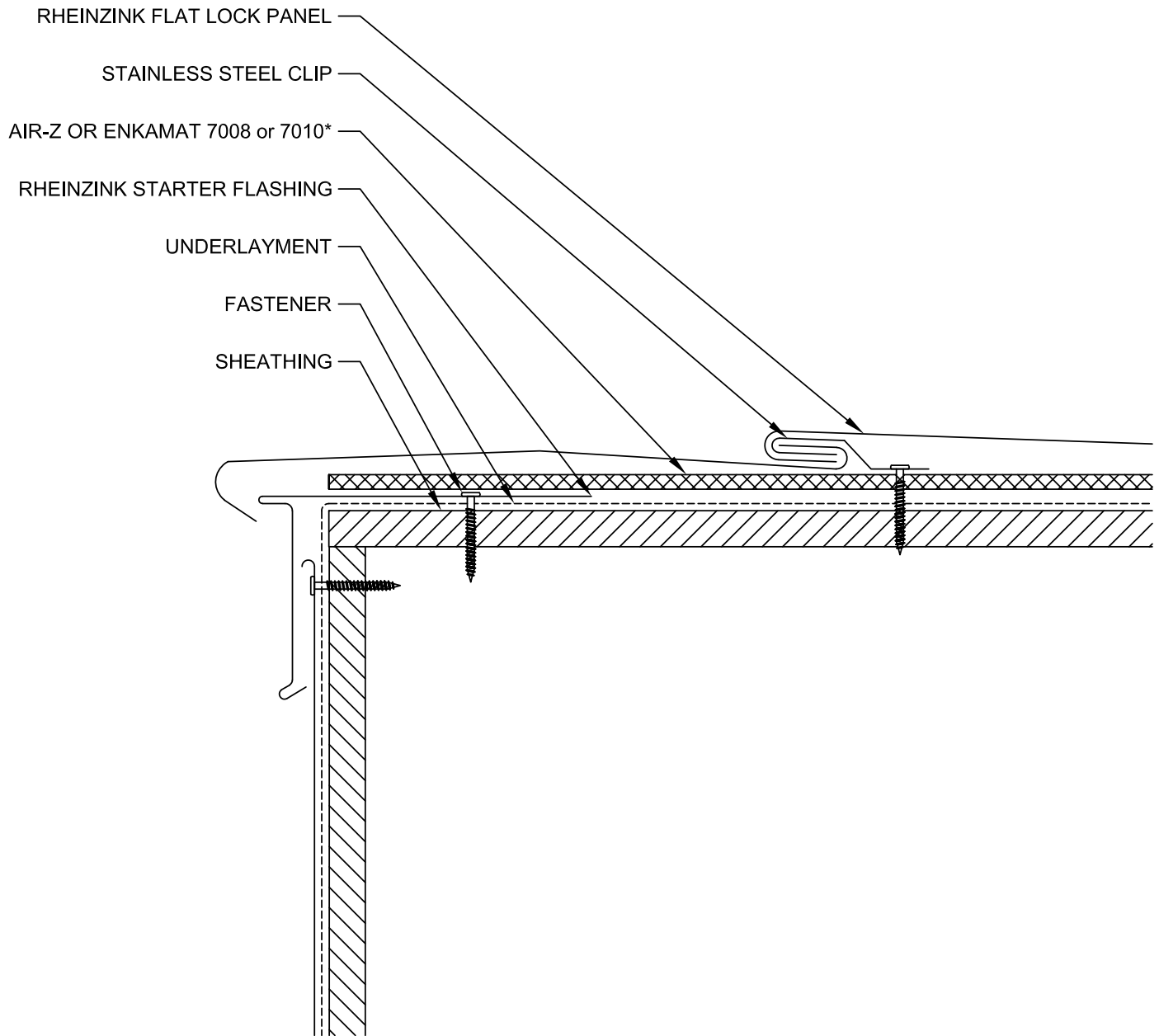

* CLIP DETAIL

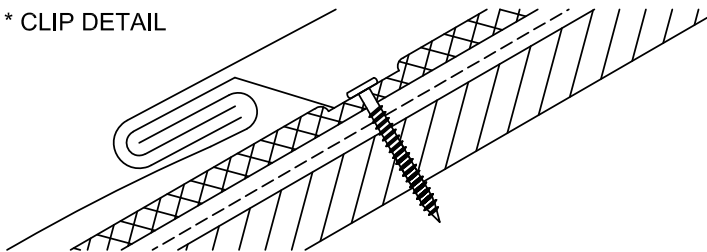

NOTES:

1. RHEINZINK RECOMMENDS STAINLESS STEEL FASTENERS AND CLIPS.
2. FLAT LOCK PANELS REQUIRE A MINIMUM OF 3:12 PITCH. FLAT LOCK PANEL ROOF SYSTEMS UP TO 6 IN 12 REQUIRE BOTH PROROOING AND AIR-Z OR ENKAMAT (7008/7010) FLAT LOCK PANELS OVER A 6 IN 12 PITCH REQUIRE AIR-Z OR ENKAMAT (7008/7010) OR PROROOING.

 96F Commerce Way Woburn, MA 01801 T: 781.729.0812 Website: www.rheinzink.us E-mail: info@rheinzink.com		
INFORMATION AND DETAILS HEREIN ARE ONLY A BASELINE FOR SYSTEM DESIGN AND INSTALLATION. MODIFICATION TO MEET PROJECT REQUIREMENTS IS THE RESPONSIBILITY OF THE DESIGNER AND ARCHITECT. RHEINZINK AMERICA STAFF ARE AVAILABLE TO ASSIST THE DESIGNER AND ARCHITECT IN THIS PROCESS. RHEINZINK AMERICA MAKES NO REPRESENTATIONS AND WARRANTIES OTHER THAN THOSE EXPRESSED HEREIN.		
PROJECT:	FLAT LOCK ROOF PANEL DETAILS	DATE: 5-2020
DRAWING TITLE:	RAKE EDGE DETAIL - OP 1	SCALE: N.T.S.
COPYRIGHT RESERVED. THIS DRAWING REMAINS THE PROPERTY OF RHEINZINK.		SHEET: FLRP-6

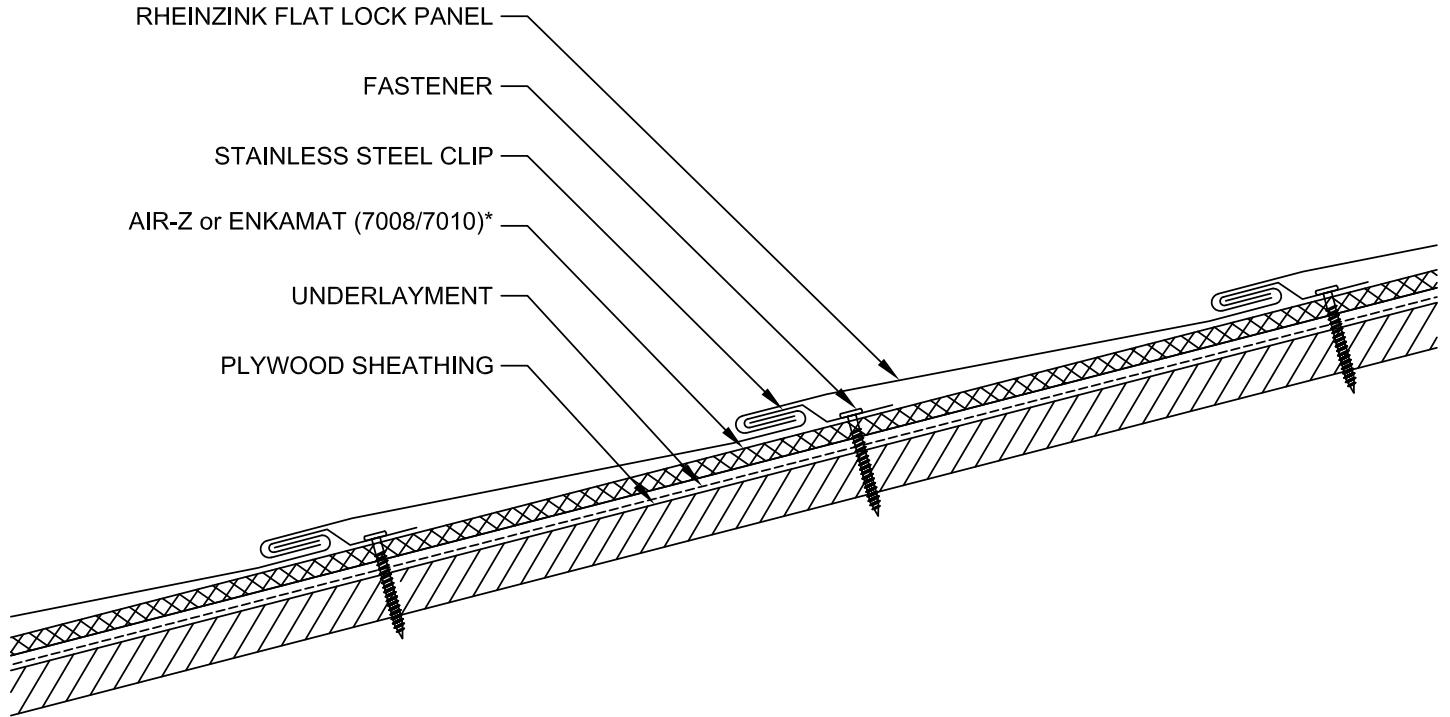

* CLIP DETAIL

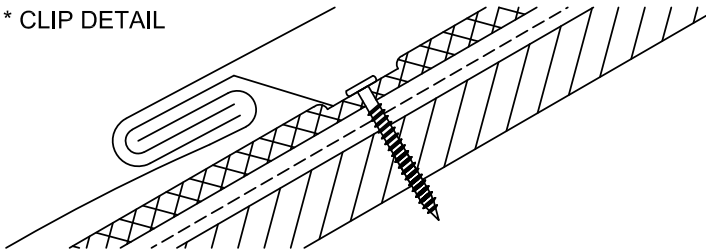

NOTES:

1. RHEINZINK RECOMMENDS STAINLESS STEEL FASTENERS AND CLIPS.
2. FLAT LOCK PANELS REQUIRE A MINIMUM OF 3:12 PITCH. FLAT LOCK PANEL ROOF SYSTEMS UP TO 6 IN 12 REQUIRE BOTH PROROOING AND AIR-Z OR ENKAMAT (7008/7010) FLAT LOCK PANELS OVER A 6 IN 12 PITCH REQUIRE AIR-Z OR ENKAMAT (7008/7010) OR PROROOING.



96F Commerce Way Woburn, MA 01801 T: 781.729.0812
 Website: www.rheinzink.us E-mail: info@rheinzink.com

INFORMATION AND DETAILS HEREIN ARE ONLY A BASELINE FOR SYSTEM DESIGN AND INSTALLATION. MODIFICATION TO MEET PROJECT REQUIREMENTS IS THE RESPONSIBILITY OF THE DESIGNER AND ARCHITECT. RHEINZINK AMERICA STAFF ARE AVAILABLE TO ASSIST THE DESIGNER AND ARCHITECT IN THIS PROCESS. RHEINZINK AMERICA MAKES NO REPRESENTATIONS AND WARRANTIES OTHER THAN THOSE EXPRESSED HEREIN.

PROJECT:	FLAT LOCK ROOF PANEL DETAILS	DATE:	5-2020
DRAWING TITLE:	CROSS JOINT DETAIL	SCALE:	N.T.S.
COPYRIGHT RESERVED. THIS DRAWING REMAINS THE PROPERTY OF RHEINZINK.		SHEET:	FLRP-7

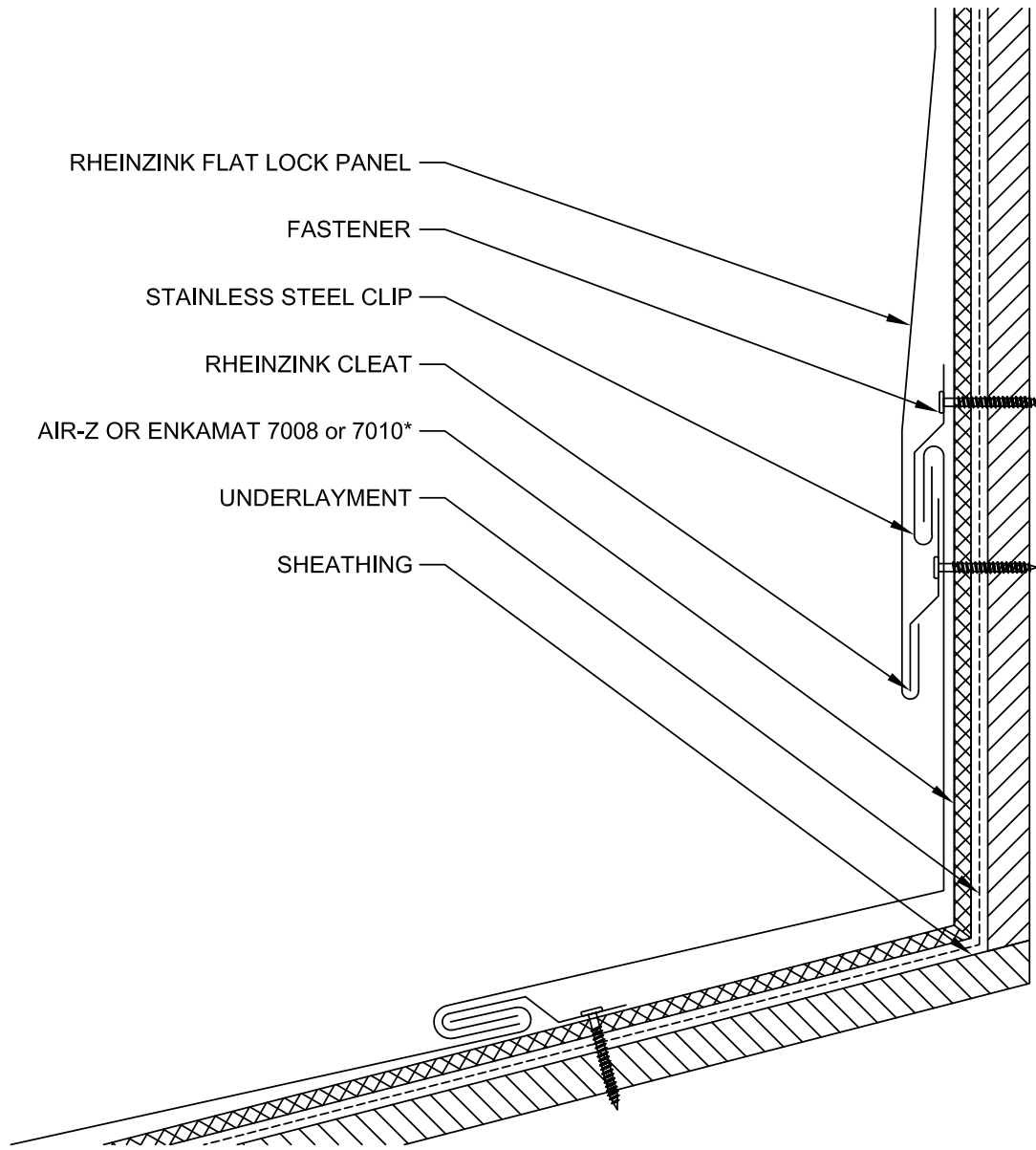

RHEINZINK FLAT LOCK PANEL
 FASTENER
 STAINLESS STEEL CLIP
 RHEINZINK CLEAT
 AIR-Z OR ENKAMAT 7008 or 7010*
 UNDERLAYMENT
 SHEATHING

* CLIP DETAIL

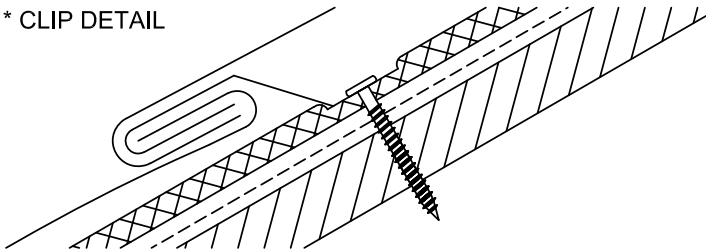

NOTES:

1. RHEINZINK RECOMMENDS STAINLESS STEEL FASTENERS AND CLIPS.
2. FLAT LOCK PANELS REQUIRE A MINIMUM OF 3:12 PITCH. FLAT LOCK PANEL ROOF SYSTEMS UP TO 6 IN 12 REQUIRE BOTH PROROOING AND AIR-Z OR ENKAMAT (7008/7010) FLAT LOCK PANELS OVER A 6 IN 12 PITCH REQUIRE AIR-Z OR ENKAMAT (7008/7010) OR PROROOING.



96F Commerce Way Woburn, MA 01801 T: 781.729.0812
 Website: www.rheinzink.us E-mail: info@rheinzink.com

INFORMATION AND DETAILS HEREIN ARE ONLY A BASELINE FOR SYSTEM DESIGN AND INSTALLATION. MODIFICATION TO MEET PROJECT REQUIREMENTS IS THE RESPONSIBILITY OF THE DESIGNER AND ARCHITECT. RHEINZINK AMERICA STAFF ARE AVAILABLE TO ASSIST THE DESIGNER AND ARCHITECT IN THIS PROCESS. RHEINZINK AMERICA MAKES NO REPRESENTATIONS AND WARRANTIES OTHER THAN THOSE EXPRESSED HEREIN.

PROJECT:	FLAT LOCK ROOF PANEL DETAILS	DATE:	5-2020
DRAWING TITLE:	ROOF TO WALLTRANSITION DETAIL	SCALE:	N.T.S.
COPYRIGHT RESERVED. THIS DRAWING REMAINS THE PROPERTY OF RHEINZINK.		SHEET:	FLRP-8

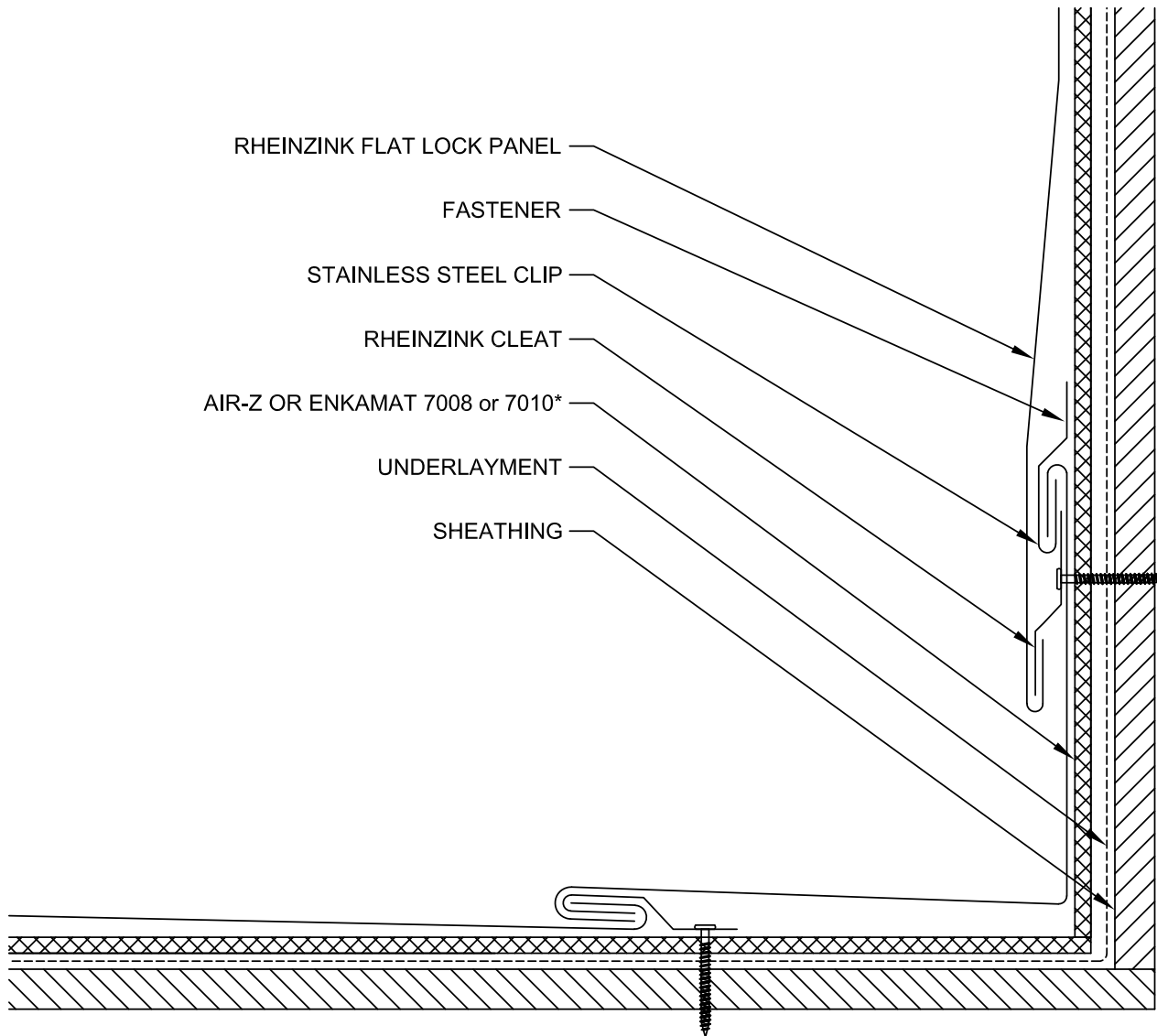

* CLIP DETAIL

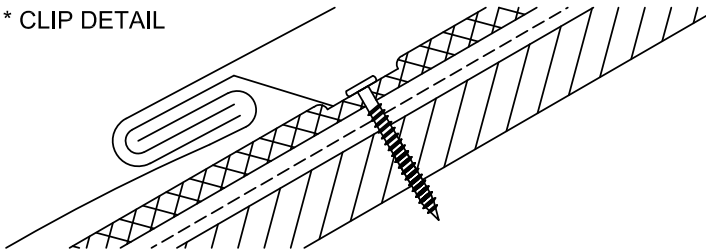

NOTES:

1. RHEINZINK RECOMMENDS STAINLESS STEEL FASTENERS AND CLIPS.
2. FLAT LOCK PANELS REQUIRE A MINIMUM OF 3:12 PITCH. FLAT LOCK PANEL ROOF SYSTEMS UP TO 6 IN 12 REQUIRE BOTH PROROOING AND AIR-Z OR ENKAMAT (7008/7010) FLAT LOCK PANELS OVER A 6 IN 12 PITCH REQUIRE AIR-Z OR ENKAMAT (7008/7010) OR PROROOING.



96F Commerce Way Woburn, MA 01801 T: 781.729.0812
 Website: www.rheinznk.us E-mail: info@rheinznk.com

INFORMATION AND DETAILS HEREIN ARE ONLY A BASELINE FOR SYSTEM DESIGN AND INSTALLATION. MODIFICATION TO MEET PROJECT REQUIREMENTS IS THE RESPONSIBILITY OF THE DESIGNER AND ARCHITECT. RHEINZINK AMERICA STAFF ARE AVAILABLE TO ASSIST THE DESIGNER AND ARCHITECT IN THIS PROCESS. RHEINZINK AMERICA MAKES NO REPRESENTATIONS AND WARRANTIES OTHER THAN THOSE EXPRESSED HEREIN.

PROJECT:	FLAT LOCK ROOF PANEL DETAILS	DATE:	5-2020
DRAWING TITLE:	SIDEWALL DETAIL	SCALE:	N.T.S.
COPYRIGHT RESERVED. THIS DRAWING REMAINS THE PROPERTY OF RHEINZINK.		SHEET:	FLRP-9

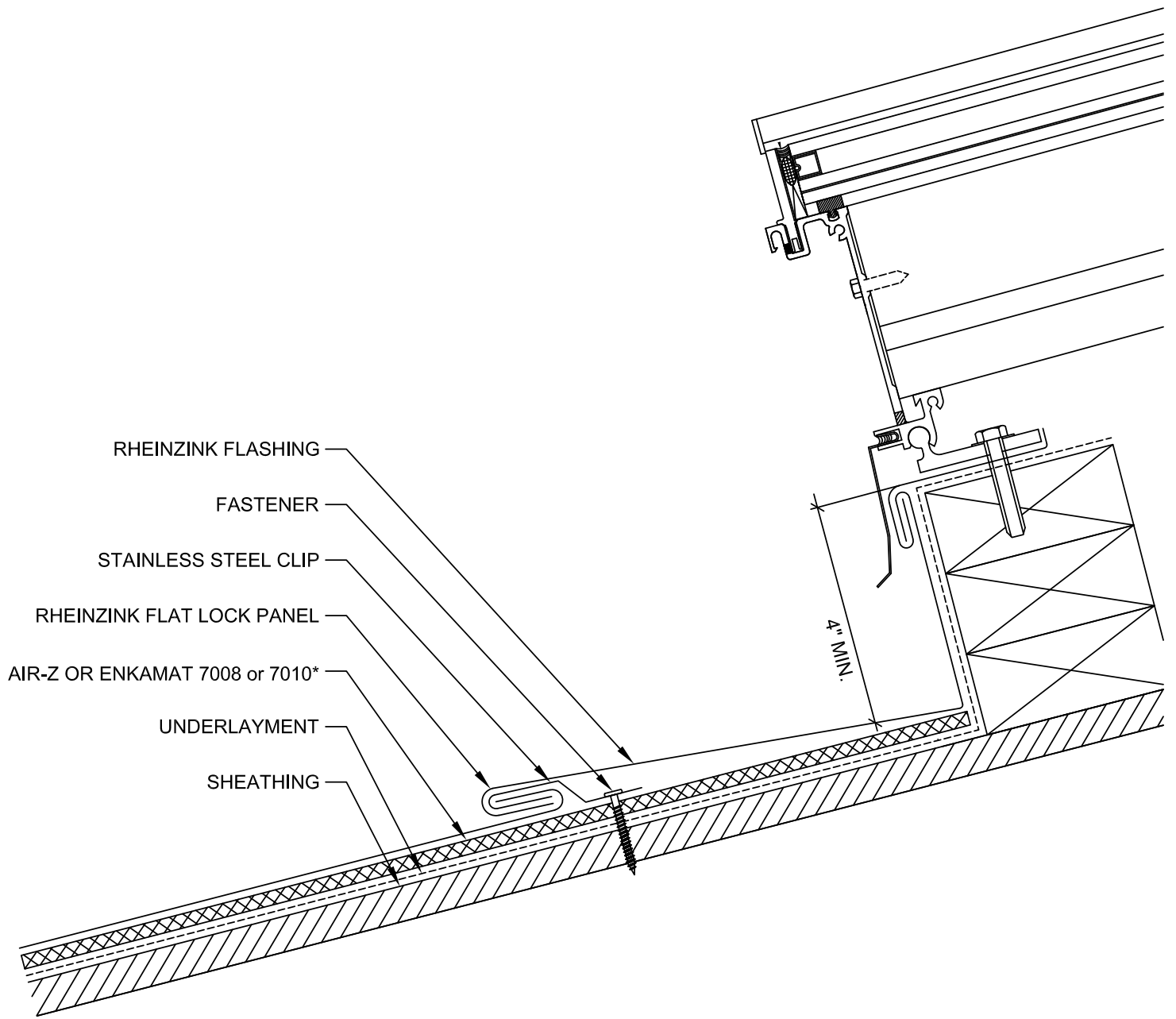

* CLIP DETAIL

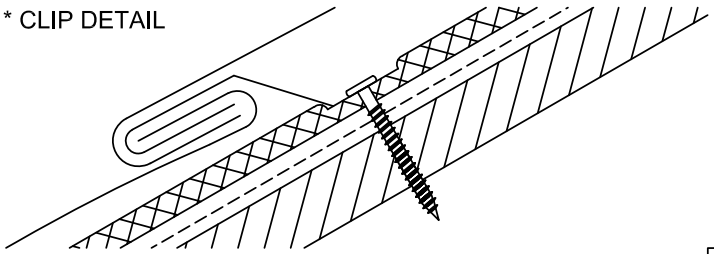

NOTES:

1. RHEINZINK RECOMMENDS STAINLESS STEEL FASTENERS AND CLIPS.
2. FLAT LOCK PANELS REQUIRE A MINIMUM OF 3:12 PITCH. FLAT LOCK PANEL ROOF SYSTEMS UP TO 6 IN 12 REQUIRE BOTH PROROOING AND AIR-Z OR ENKAMAT (7008/7010) FLAT LOCK PANELS OVER A 6 IN 12 PITCH REQUIRE AIR-Z OR ENKAMAT (7008/7010) OR PROROOING.

 96F Commerce Way Woburn, MA 01801 T: 781.729.0812 Website: www.rheinzink.us E-mail: info@rheinzink.com		
INFORMATION AND DETAILS HEREIN ARE ONLY A BASELINE FOR SYSTEM DESIGN AND INSTALLATION. MODIFICATION TO MEET PROJECT REQUIREMENTS IS THE RESPONSIBILITY OF THE DESIGNER AND ARCHITECT. RHEINZINK AMERICA STAFF ARE AVAILABLE TO ASSIST THE DESIGNER AND ARCHITECT IN THIS PROCESS. RHEINZINK AMERICA MAKES NO REPRESENTATIONS AND WARRANTIES OTHER THAN THOSE EXPRESSED HEREIN.		
PROJECT:	FLAT LOCK ROOF PANEL DETAILS	DATE: 5-2020
DRAWING TITLE:	SKYLIGHT SILL DETAIL	SCALE: N.T.S.
COPYRIGHT RESERVED. THIS DRAWING REMAINS THE PROPERTY OF RHEINZINK.		SHEET: FLRP-10

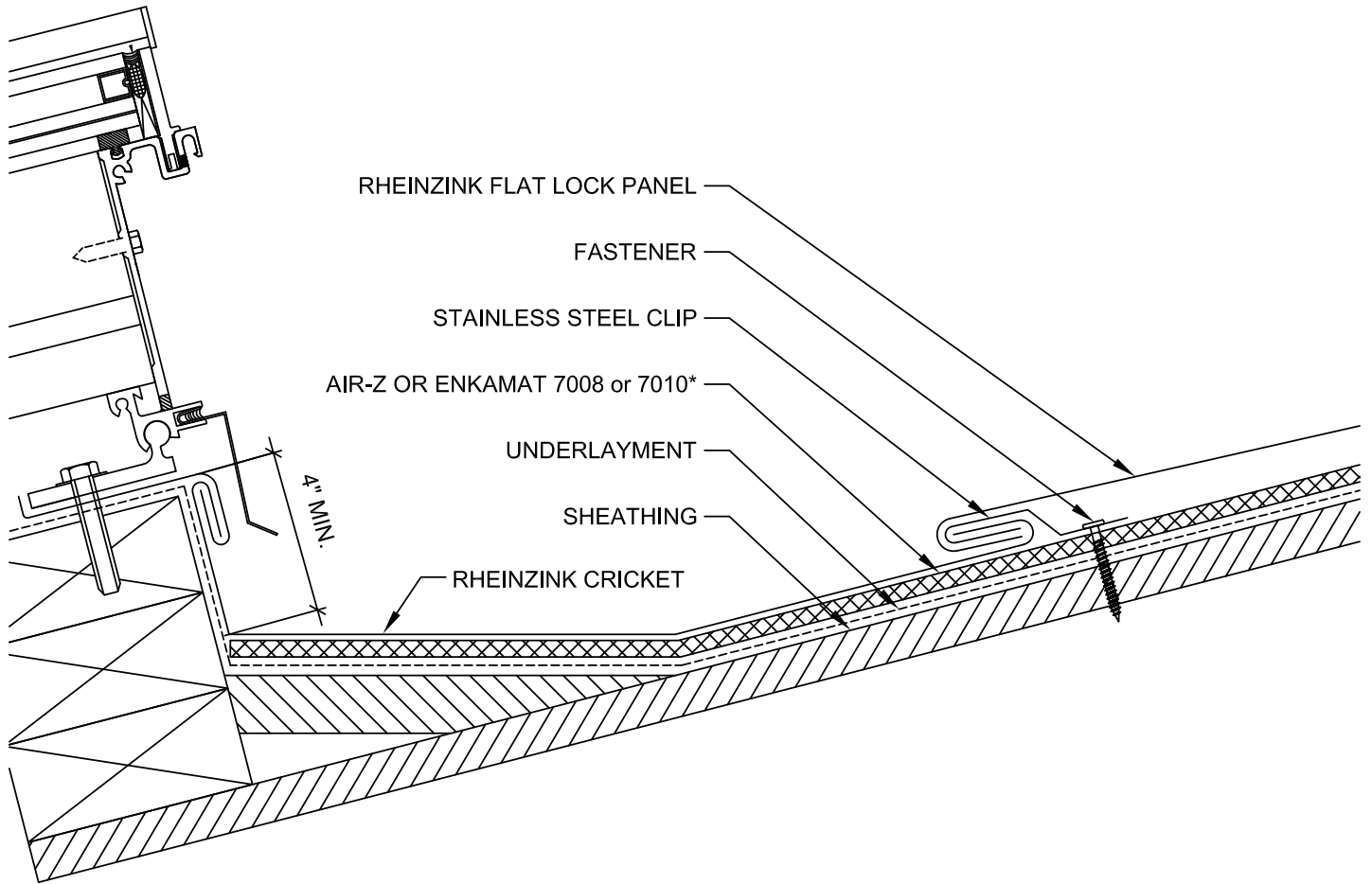

* CLIP DETAIL

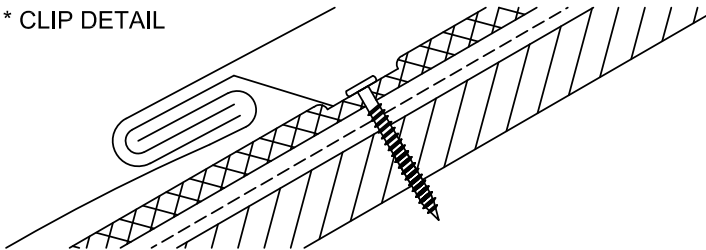

NOTES:

1. RHEINZINK RECOMMENDS STAINLESS STEEL FASTENERS AND CLIPS.
2. FLAT LOCK PANELS REQUIRE A MINIMUM OF 3:12 PITCH. FLAT LOCK PANEL ROOF SYSTEMS UP TO 6 IN 12 REQUIRE BOTH PROROOING AND AIR-Z OR ENKAMAT (7008/7010) FLAT LOCK PANELS OVER A 6 IN 12 PITCH REQUIRE AIR-Z OR ENKAMAT (7008/7010) OR PROROOING.



96F Commerce Way Woburn, MA 01801 T: 781.729.0812
 Website: www.rheinzink.us E-mail: info@rheinzink.com

INFORMATION AND DETAILS HEREIN ARE ONLY A BASELINE FOR SYSTEM DESIGN AND INSTALLATION. MODIFICATION TO MEET PROJECT REQUIREMENTS IS THE RESPONSIBILITY OF THE DESIGNER AND ARCHITECT. RHEINZINK AMERICA STAFF ARE AVAILABLE TO ASSIST THE DESIGNER AND ARCHITECT IN THIS PROCESS. RHEINZINK AMERICA MAKES NO REPRESENTATIONS AND WARRANTIES OTHER THAN THOSE EXPRESSED HEREIN.

PROJECT:	FLAT LOCK ROOF PANEL DETAILS	DATE:	5-2020
DRAWING TITLE:	SKYLIGHT HEAD DETAIL	SCALE:	N.T.S.
COPYRIGHT RESERVED. THIS DRAWING REMAINS THE PROPERTY OF RHEINZINK.		SHEET:	FLRP-11

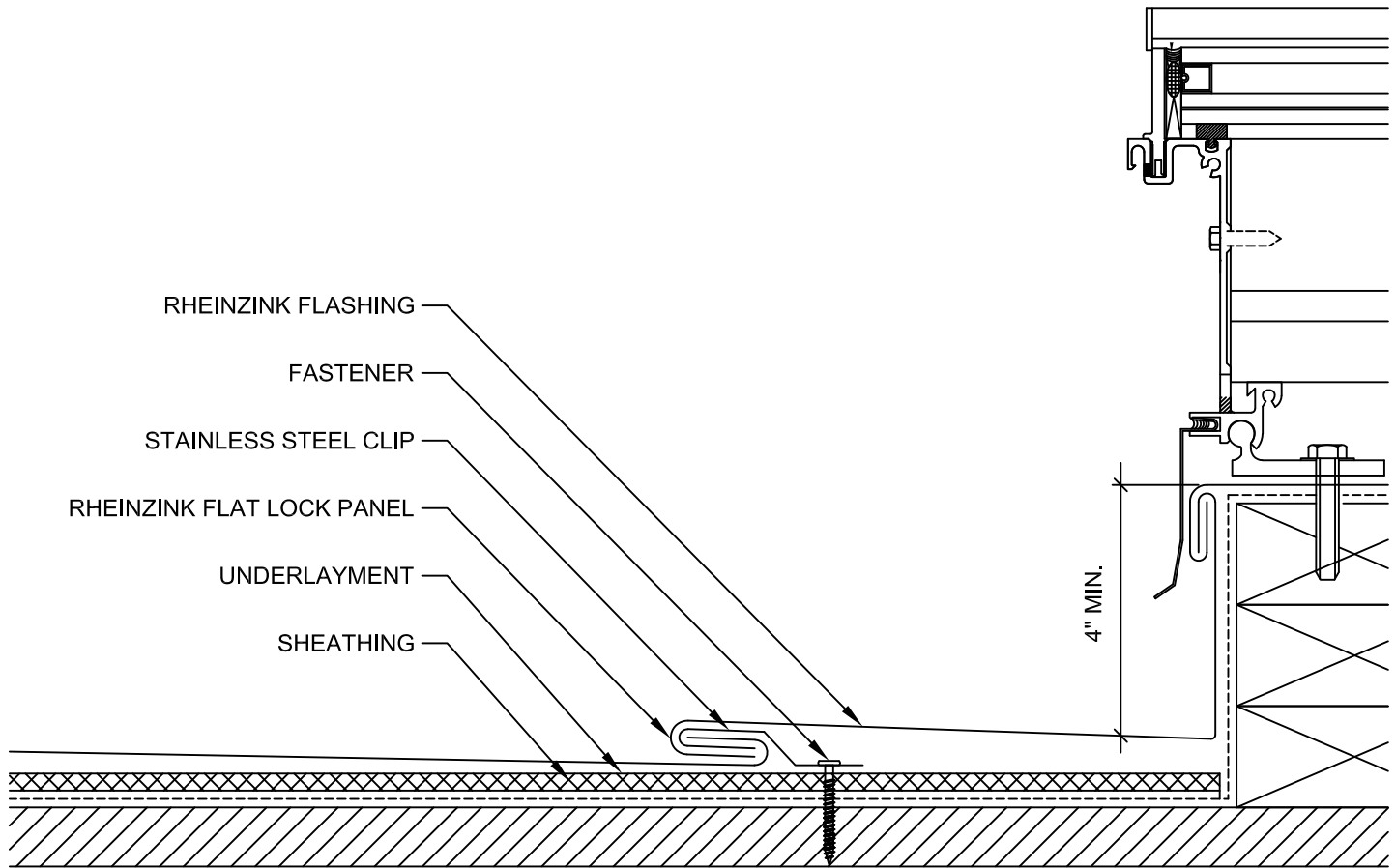

* CLIP DETAIL

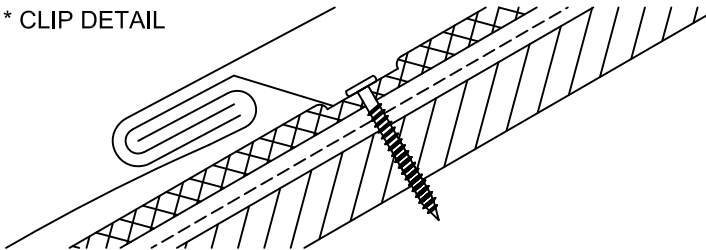

NOTES:

1. RHEINZINK RECOMMENDS STAINLESS STEEL FASTENERS AND CLIPS.
2. FLAT LOCK PANELS REQUIRE A MINIMUM OF 3:12 PITCH. FLAT LOCK PANEL ROOF SYSTEMS UP TO 6 IN 12 REQUIRE BOTH PROROOING AND AIR-Z OR ENKAMAT (7008/7010) FLAT LOCK PANELS OVER A 6 IN 12 PITCH REQUIRE AIR-Z OR ENKAMAT (7008/7010) OR PROROOING.



96F Commerce Way Woburn, MA 01801 T: 781.729.0812
 Website: www.rheinznk.us E-mail: info@rheinznk.com

INFORMATION AND DETAILS HEREIN ARE ONLY A BASELINE FOR SYSTEM DESIGN AND INSTALLATION. MODIFICATION TO MEET PROJECT REQUIREMENTS IS THE RESPONSIBILITY OF THE DESIGNER AND ARCHITECT. RHEINZINK AMERICA STAFF ARE AVAILABLE TO ASSIST THE DESIGNER AND ARCHITECT IN THIS PROCESS. RHEINZINK AMERICA MAKES NO REPRESENTATIONS AND WARRANTIES OTHER THAN THOSE EXPRESSED HEREIN.

PROJECT:	FLAT LOCK ROOF PANEL DETAILS	DATE:	5-2020
DRAWING TITLE:	SKYLIGHT JAMB DETAIL	SCALE:	N.T.S.
COPYRIGHT RESERVED. THIS DRAWING REMAINS THE PROPERTY OF RHEINZINK.		SHEET:	FLRP-12

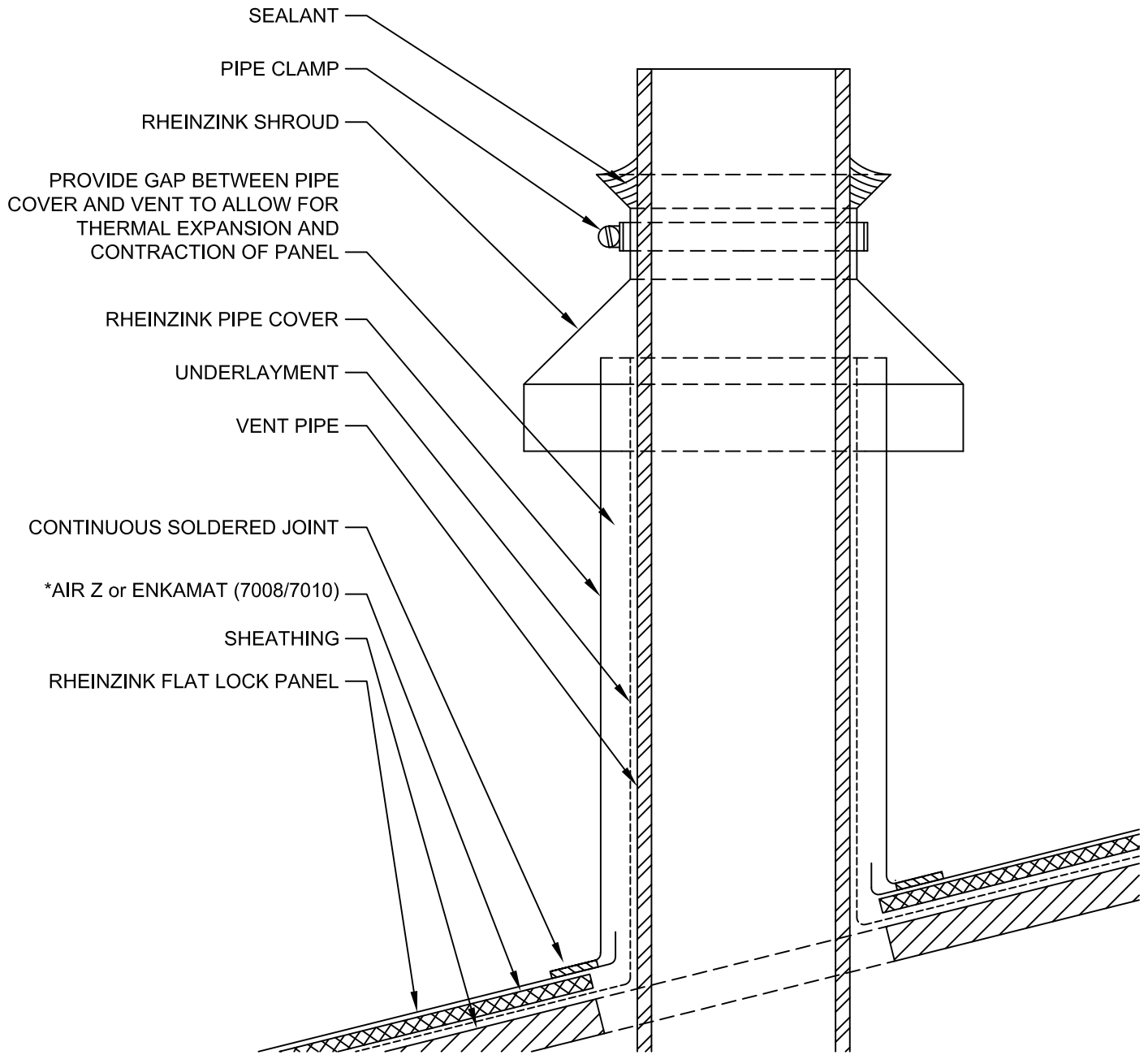

* CLIP DETAIL

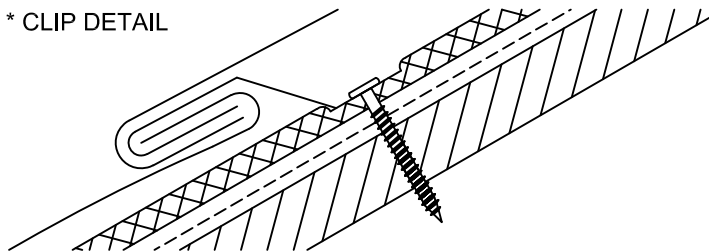

NOTES:

1. RHEINZINK RECOMMENDS STAINLESS STEEL FASTENERS AND CLIPS.
2. FLAT LOCK PANELS REQUIRE A MINIMUM OF 3:12 PITCH. FLAT LOCK PANEL ROOF SYSTEMS UP TO 6 IN 12 REQUIRE BOTH PROROOING AND AIR-Z OR ENKAMAT (7008/7010) FLAT LOCK PANELS OVER A 6 IN 12 PITCH REQUIRE AIR-Z OR ENKAMAT (7008/7010) OR PROROOING.



96F Commerce Way Woburn, MA 01801 T: 781.729.0812
 Website: www.rheinzink.us E-mail: info@rheinzink.com

INFORMATION AND DETAILS HEREIN ARE ONLY A BASELINE FOR SYSTEM DESIGN AND INSTALLATION. MODIFICATION TO MEET PROJECT REQUIREMENTS IS THE RESPONSIBILITY OF THE DESIGNER AND ARCHITECT. RHEINZINK AMERICA STAFF ARE AVAILABLE TO ASSIST THE DESIGNER AND ARCHITECT IN THIS PROCESS. RHEINZINK AMERICA MAKES NO REPRESENTATIONS AND WARRANTIES OTHER THAN THOSE EXPRESSED HEREIN.

PROJECT:	FLAT LOCK ROOF PANEL DETAILS	DATE:	5-2020
DRAWING TITLE:	VENT PIPE PENETRATION DETAIL	SCALE:	N.T.S.
COPYRIGHT RESERVED. THIS DRAWING REMAINS THE PROPERTY OF RHEINZINK.		SHEET:	FLRP-13

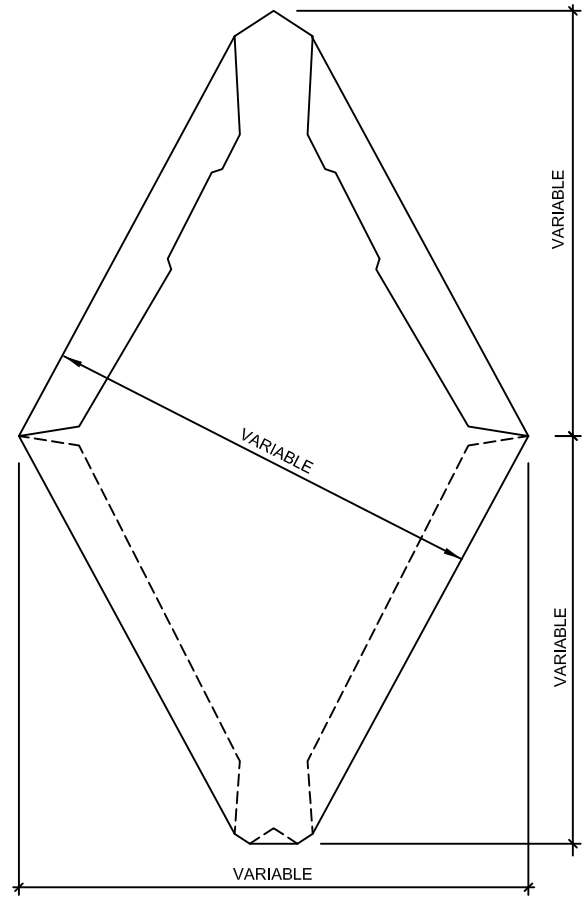
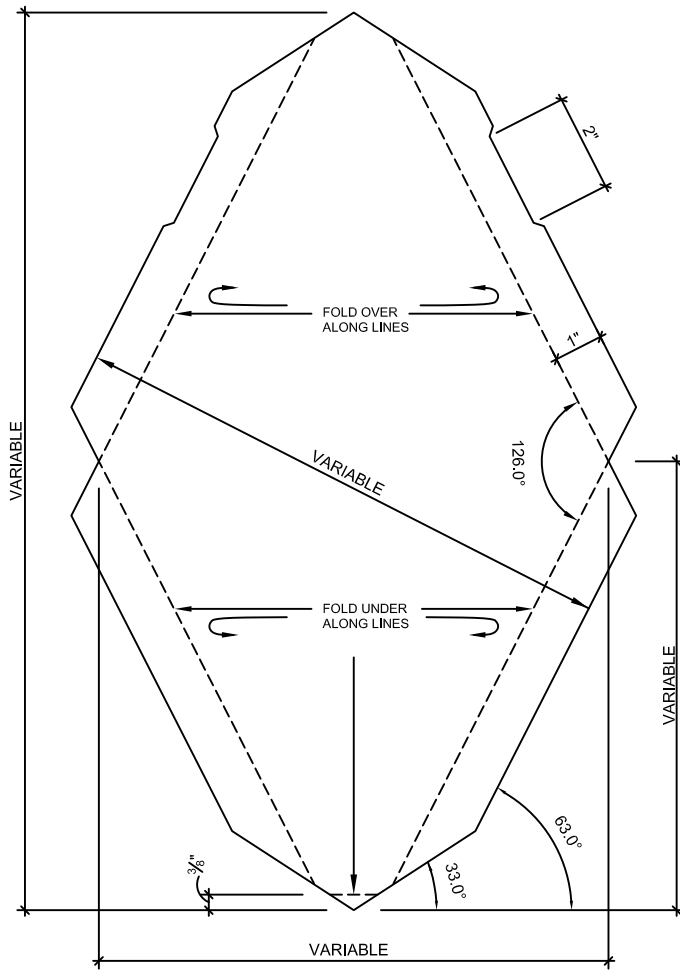

* CLIP DETAIL

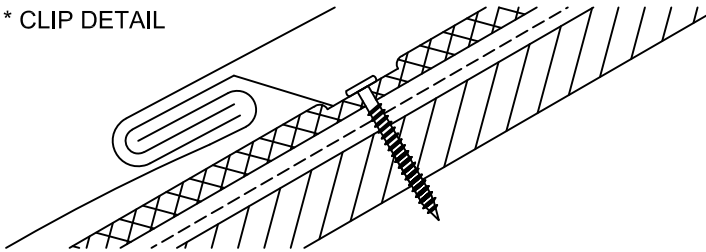

NOTES:

1. RHEINZINK RECOMMENDS STAINLESS STEEL FASTENERS AND CLIPS.
2. FLAT LOCK PANELS REQUIRE A MINIMUM OF 3:12 PITCH. FLAT LOCK PANEL ROOF SYSTEMS UP TO 6 IN 12 REQUIRE BOTH PROROOING AND AIR-Z OR ENKAMAT (7008/7010) FLAT LOCK PANELS OVER A 6 IN 12 PITCH REQUIRE AIR-Z OR ENKAMAT (7008/7010) OR PROROOING.



96F Commerce Way Woburn, MA 01801 T: 781.729.0812
 Website: www.rheinznk.us E-mail: info@rheinznk.com

INFORMATION AND DETAILS HEREIN ARE ONLY A BASELINE FOR SYSTEM DESIGN AND INSTALLATION. MODIFICATION TO MEET PROJECT REQUIREMENTS IS THE RESPONSIBILITY OF THE DESIGNER AND ARCHITECT. RHEINZINK AMERICA STAFF ARE AVAILABLE TO ASSIST THE DESIGNER AND ARCHITECT IN THIS PROCESS. RHEINZINK AMERICA MAKES NO REPRESENTATIONS AND WARRANTIES OTHER THAN THOSE EXPRESSED HEREIN.

PROJECT:	FLAT LOCK ROOF PANEL DETAILS	DATE:	5-2020
DRAWING TITLE:	DIAMOND FABRICATION DETAIL	SCALE:	N.T.S.
COPYRIGHT RESERVED. THIS DRAWING REMAINS THE PROPERTY OF RHEINZINK.		SHEET:	FLRP-14

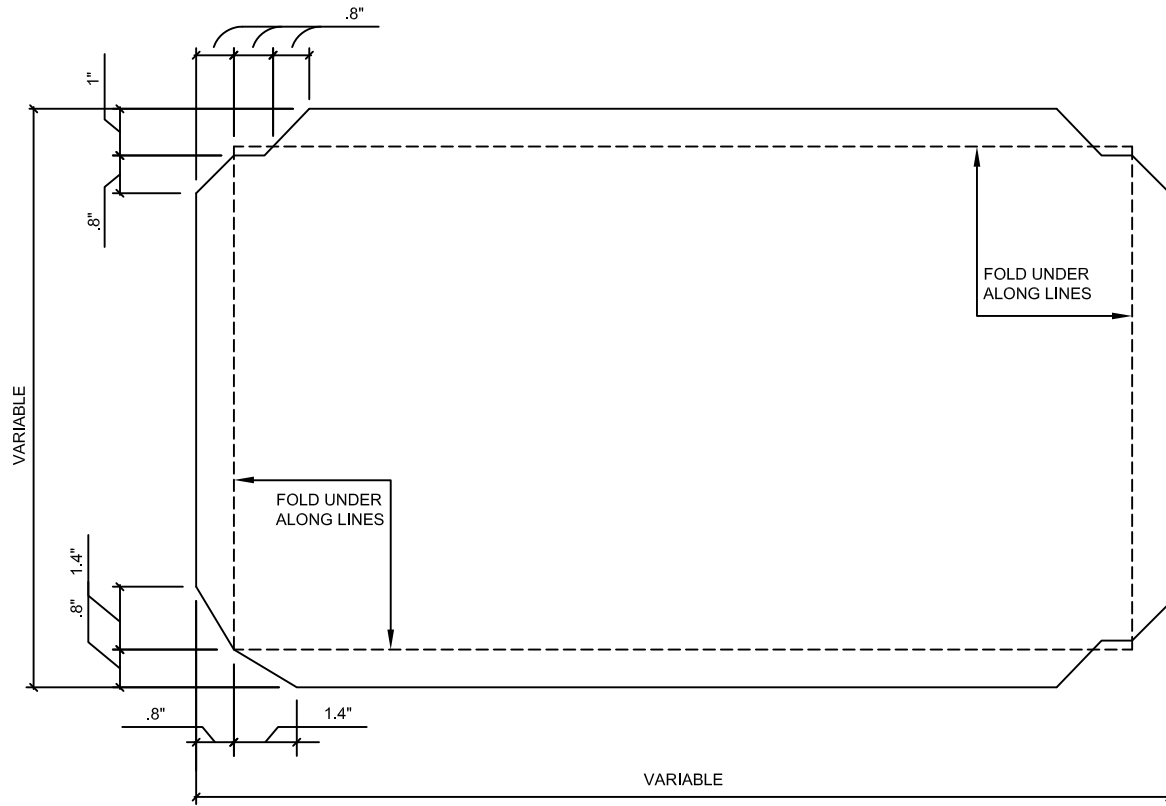

* CLIP DETAIL

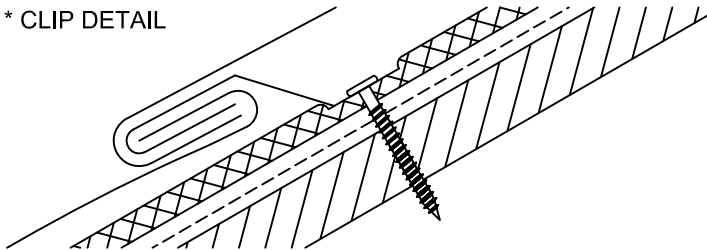

NOTES:

1. RHEINZINK RECOMMENDS STAINLESS STEEL FASTENERS AND CLIPS.
2. FLAT LOCK PANELS REQUIRE A MINIMUM OF 3:12 PITCH. FLAT LOCK PANEL ROOF SYSTEMS UP TO 6 IN 12 REQUIRE BOTH PROROOING AND AIR-Z OR ENKAMAT (7008/7010) FLAT LOCK PANELS OVER A 6 IN 12 PITCH REQUIRE AIR-Z OR ENKAMAT (7008/7010) OR PROROOING.



96F Commerce Way Woburn, MA 01801 T: 781.729.0812
 Website: www.rheinzink.us E-mail: info@rheinzink.com

INFORMATION AND DETAILS HEREIN ARE ONLY A BASELINE FOR SYSTEM DESIGN AND INSTALLATION. MODIFICATION TO MEET PROJECT REQUIREMENTS IS THE RESPONSIBILITY OF THE DESIGNER AND ARCHITECT. RHEINZINK AMERICA STAFF ARE AVAILABLE TO ASSIST THE DESIGNER AND ARCHITECT IN THIS PROCESS. RHEINZINK AMERICA MAKES NO REPRESENTATIONS AND WARRANTIES OTHER THAN THOSE EXPRESSED HEREIN.

PROJECT:	FLAT LOCK ROOF PANEL DETAILS	DATE:	5-2020
DRAWING TITLE:	RECTANGULAR FAB DETAIL - H	SCALE:	N.T.S.
COPYRIGHT RESERVED. THIS DRAWING REMAINS THE PROPERTY OF RHEINZINK.		SHEET:	FLRP-15A

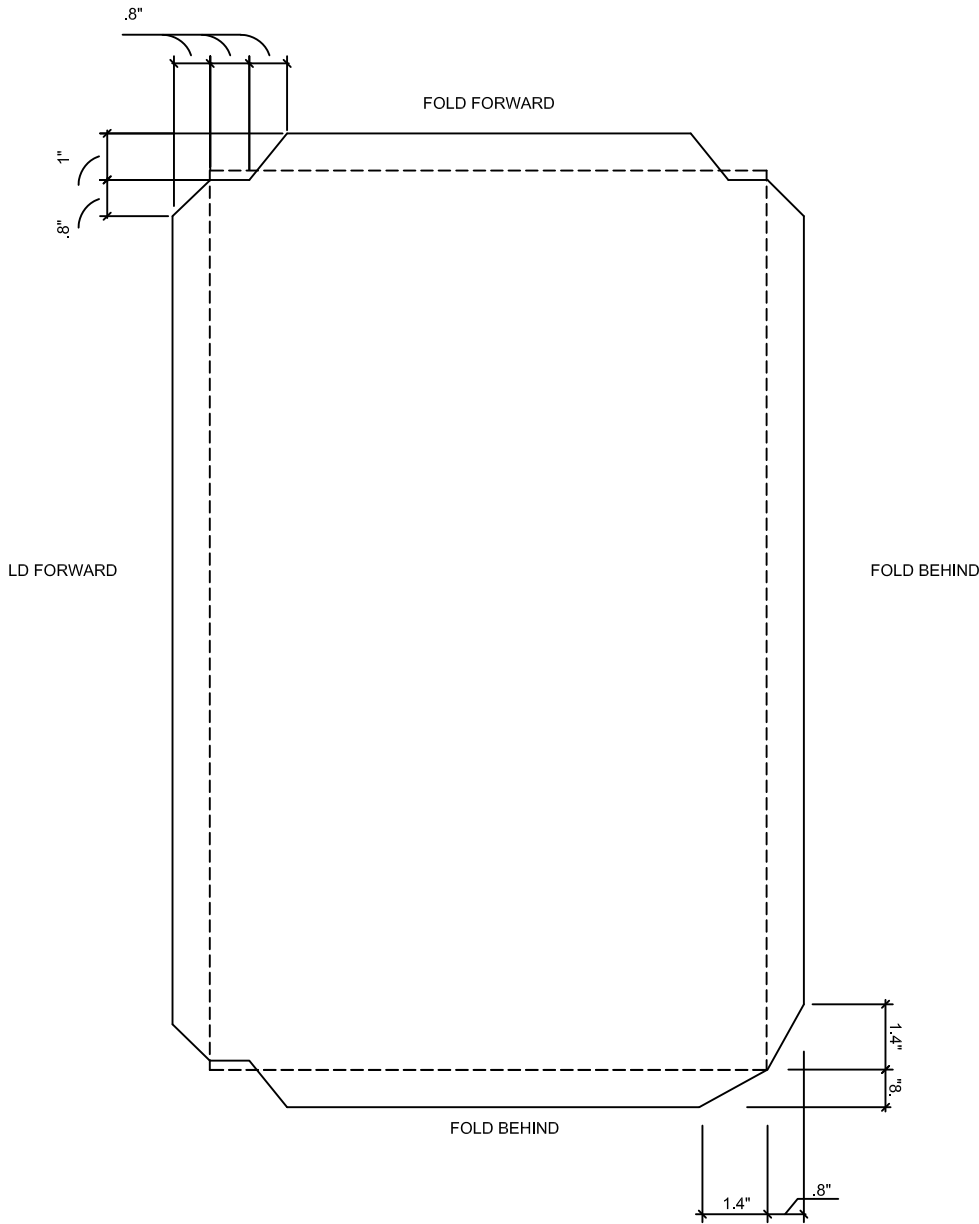

* CLIP DETAIL

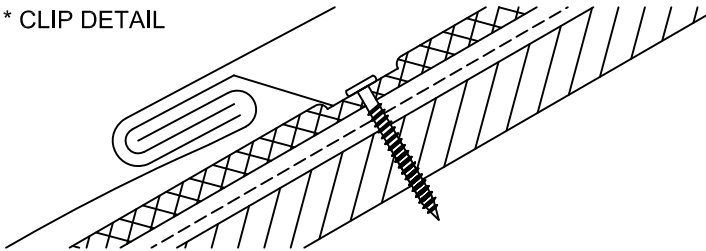

NOTES:

1. RHEINZINK RECOMMENDS STAINLESS STEEL FASTENERS AND CLIPS.
2. FLAT LOCK PANELS REQUIRE A MINIMUM OF 3:12 PITCH. FLAT LOCK PANEL ROOF SYSTEMS UP TO 6 IN 12 REQUIRE BOTH PROROOING AND AIR-Z OR ENKAMAT (7008/7010) FLAT LOCK PANELS OVER A 6 IN 12 PITCH REQUIRE AIR-Z OR ENKAMAT (7008/7010) OR PROROOING.



96F Commerce Way Woburn, MA 01801 T: 781.729.0812
 Website: www.rheinzink.us E-mail: info@rheinzink.com

INFORMATION AND DETAILS HEREIN ARE ONLY A BASELINE FOR SYSTEM DESIGN AND INSTALLATION. MODIFICATION TO MEET PROJECT REQUIREMENTS IS THE RESPONSIBILITY OF THE DESIGNER AND ARCHITECT. RHEINZINK AMERICA STAFF ARE AVAILABLE TO ASSIST THE DESIGNER AND ARCHITECT IN THIS PROCESS. RHEINZINK AMERICA MAKES NO REPRESENTATIONS AND WARRANTIES OTHER THAN THOSE EXPRESSED HEREIN.

PROJECT:	FLAT LOCK PANEL ROOF DETAILS	DATE:	5-2020
DRAWING TITLE:	RECTANGULAR FAB DETAIL - V	SCALE:	N.T.S.
COPYRIGHT RESERVED. THIS DRAWING REMAINS THE PROPERTY OF RHEINZINK.		SHEET:	FLRP-15B

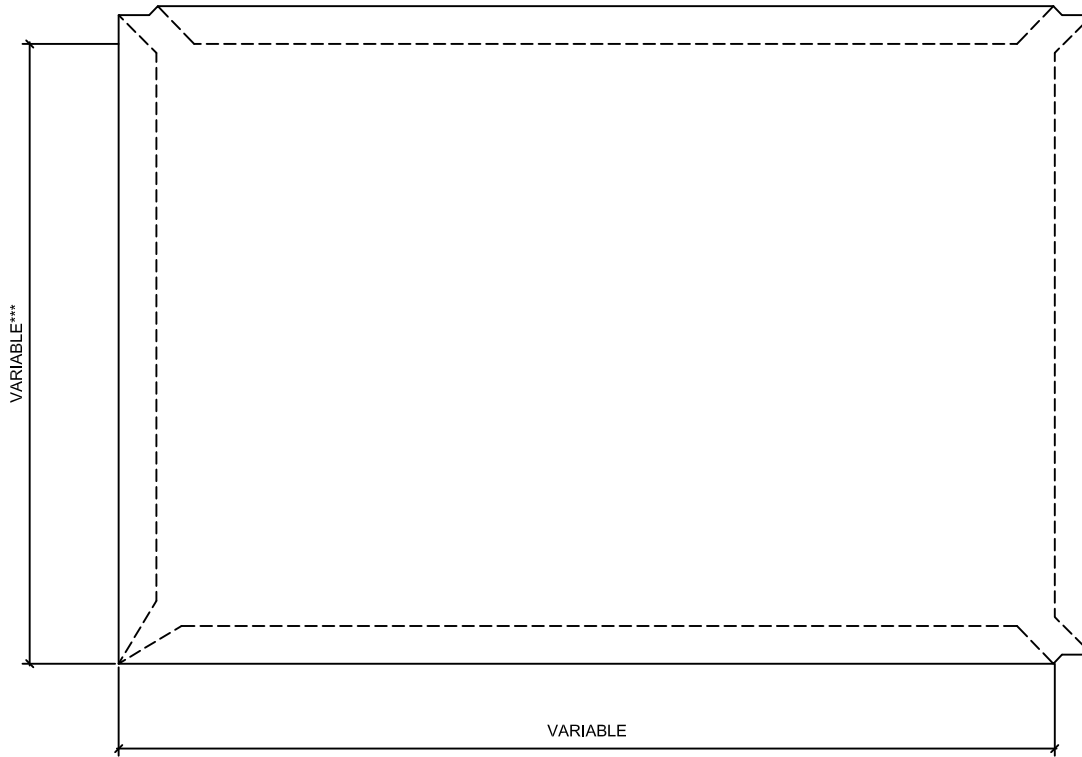

* CLIP DETAIL

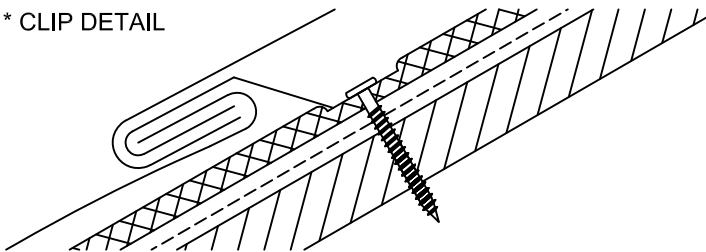

NOTES:

1. RHEINZINK RECOMMENDS STAINLESS STEEL FASTENERS AND CLIPS.
2. FLAT LOCK PANELS REQUIRE A MINIMUM OF 3:12 PITCH. FLAT LOCK PANEL ROOF SYSTEMS UP TO 6 IN 12 REQUIRE BOTH PROROOING AND AIR-Z OR ENKAMAT (7008/7010). FLAT LOCK PANELS OVER A 6 IN 12 PITCH REQUIRE AIR-Z OR ENKAMAT (7008/7010) OR PROROOING.
3. CLIP QUANTITY AND SPACING TO BE DETERMINED BY ENGINEERING CALCULATIONS

 96F Commerce Way Woburn, MA 01801 T: 781.729.0812 Website: www.rheinznk.us E-mail: info@rheinznk.com	
INFORMATION AND DETAILS HEREIN ARE ONLY A BASELINE FOR SYSTEM DESIGN AND INSTALLATION. MODIFICATION TO MEET PROJECT REQUIREMENTS IS THE RESPONSIBILITY OF THE DESIGNER AND ARCHITECT. RHEINZINK AMERICA STAFF ARE AVAILABLE TO ASSIST THE DESIGNER AND ARCHITECT IN THIS PROCESS. RHEINZINK AMERICA MAKES NO REPRESENTATIONS AND WARRANTIES OTHER THAN THOSE EXPRESSED HEREIN.	
PROJECT:	FLAT LOCK ROOF PANEL DETAILS DATE: 5-2020
DRAWING TITLE:	RECT FAB DETAIL - H FOLDED SCALE: N.T.S.
COPYRIGHT RESERVED. THIS DRAWING REMAINS THE PROPERTY OF RHEINZINK.	SHEET: FLRP-15C