



# STANDING SEAM

System Technology for Roofing

DESIGN AND APPLICATION



Mormon Temple, Tucson, AZ



Residence in Capetown, South Africa



Geschäftshaus Wensler, New Church, Germany

### Standing Seam Roof System

1. This system may be fabricated from the following PRODUCT LINES:

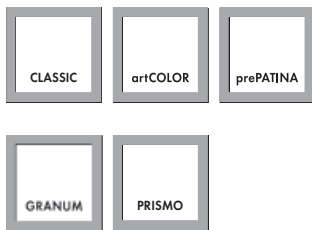

2. Easy to fabricate and install.
3. Panel widths from 12" to 24".
4. For optimum flatness:
  - Use 0.8 mm thick RHEINZINK for panel widths 17" to 24".
  - Use 0.7 mm thick RHEINZINK for panel heights 12" to 17".
  - For panel widths above 18" additional profiling is recommended.
5. For cost effectiveness, ease of fabrication and installation, limit panel lengths to 40', although the maximum allowable length of 52' is possible.
 

Consult the RHEINZINK technical department for applications requiring longer lengths.
6. It is recommended to single lock the panels every 3'-4' prior to seaming to assure proper seam closure.
7. Refer to the RHEINZINK baseline details for detail options for eaves, rakes, hips, ridges, valleys and penetrations. Consult the RHEINZINK technical department for customized applications.
8. Panels can be roll formed or fabrication fabricated using brake forming or folding machines.
9. To determine whether a ventilation mat and/or factory applied ProRoofing backside coating is required for RHEINZINK standing seam roofing panels, please refer to the RHEINZINK Steep Slope, Mid Slope and Low Slope Roofing recommendations.
10. All roof installations require Air-Z or Enkamat (7008 or 7010).
11. Roof penetrations such as skylights, chimneys or vents that interrupt the seams constitute the most vulnerable part of any standing seam roof. These areas must be carefully detailed fully with apron flashings with sufficient overlap lengths, capillary breaks, and waterchecks. Consult a RHEINZINK representative for advice on proper details for these conditions.

Photo on page prior: Private Residence, Moskauer Gebiet, Russia

ROOF SLOPE CALCULATIONS

Pitch	Angle	Roof Pitch in Percentage	Roof Pitch in Degrees
1 : 12	3.75°	8.33%	4.76°
2 : 12	7.50°	16.67%	9.46°
3 : 12	11.25°	25.00%	14.04°
4 : 12	15.00°	33.33%	18.43°
5 : 12	18.75°	41.67%	22.62°
6 : 12	22.50°	50.00%	26.57°
7 : 12	26.25°	58.33%	30.26°
8 : 12	30.00°	66.67%	33.69°
9 : 12	33.50°	75.00%	36.87°
10 : 12	37.50°	83.33%	39.81°
11 : 12	41.25°	91.67%	42.51°
12 : 12	45.00°	100.00%	45.00°

1:12



2:12



3:12

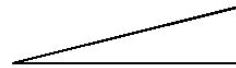

4:12

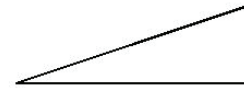

5:12

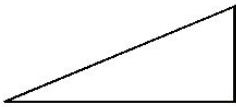

6:12

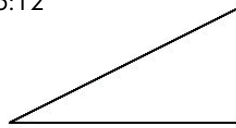

7:12

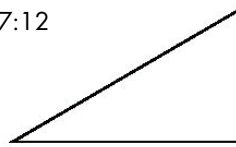

8:12

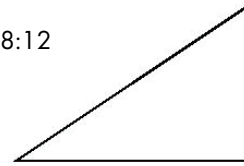

9:12

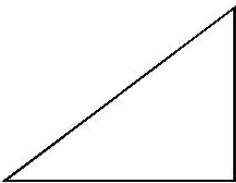

10:12

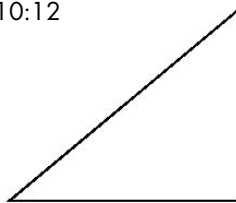

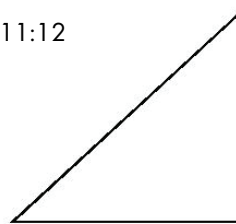

11:12

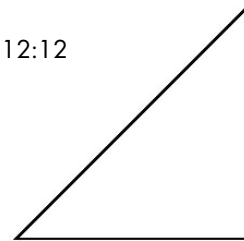

12:12

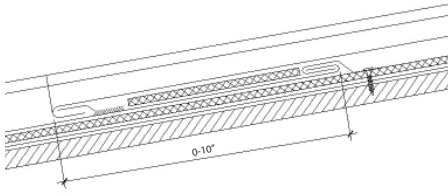





<b>Roofing Application:</b>	<b>Low Slope: (&lt;3 in 12)</b>
<b>Double Lock Standing Seam:</b>	Air Z or Enkamat 7008 or 7010 <b>and</b> ProRoofing  + 
<b>Angle Lock Standing Seam:</b>	This application is not recommended by RHEINZINK.

1. A roof with a pitch of 3 in 12 or less is a low slope roof. Barrel vaulted or curved roofs usually have low slope conditions on at least a portion of the roof.
2. Low slope roofs require a high temperature, peel and stick, self adhesive membrane as the underlayment. Breathable membranes are not appropriate underlayments for low slope standing seam roof conditions. In cold climates where roof assembly ventilation may be desirable, consideration should be given to the fact that a peel and stick membrane is a non breathable vapor barrier and therefore does not promote drying of condensation in the roof assembly through the roof surface itself.
3. Low slope standing seam roofs must have continuous positive drainage at a minimum pitch of 5/8" in 12. However, the steeper the pitch, the less chance of a leak especially in areas with extended snow cover. Also, valleys must have a minimum pitch of 5/8" in 12. Beware! The resulting valley pitch of two intersecting 5/8" in 12 pitched roofs that are oriented perpendicularly to each other is less than 1/2" in 12. Low slope roofs with long lengths should generally be pitched greater than 5/8" in 12 because over a larger roof plane there is a greater chance that the supporting substrate will have swales that create puddles.
4. Low slope standing seam roofs with slopes less than 3 in 12 should not have any cross seams. Panels must therefore run the full length of the roof plane or arc. Panels that are longer than 40' will most likely have to be roll formed at the site.
5. Low slope roofs require the added weather resistance of a double locked seam. Single lock seams are not appropriate for low slope roofs. Valleys should have a water check and an additional soldered cleat 10" from the water check for engagement of the roof panels or other lengths of valley.
6. In areas of high snow fall, the seam height should be 1-1/2" tall (instead of the standard 1") height for additional weather resistance.
7. The standing seams should be sealed continuously with either butyl sealant or closed cell urethane foam placed on the top of the male leg. The use of urethane foam requires an adjustment, prior to fabricating, to the female leg of the seam to compensate for the thickness of the foam.
8. Low slope roofs with pitches of less than 3 in 12 require the added protection of both backside coating (ProRoofing) and a drainage mat - RHEINZINK Air-Z or Enkamat (7008 or 7010) by Bonar.
9. Attachment clips and their associated fasteners for low slope standing seam roofs should be made of stainless steel.
10. Roof penetrations such as skylights, chimneys, or vents that interrupt the seams constitute the most vulnerable part of any standing seam roof. These areas must be detailed carefully with apron flashings with sufficient overlap lengths, capillary breaks, and water checks. Consult your RHEINZINK representative for advice on proper details for these conditions.
11. Terminate eave ends of panels by leaving the underside of the eave hook horizontal to facilitate drainage of leakage or condensation.
12. All roof installations require Air-Z or Enkamat (7008 or 7010).

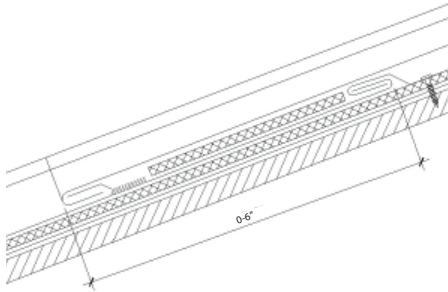
MID SLOPE STANDING SEAM ROOFING WITH RHEINZINK



<b>Roofing Application:</b>	<b>Mid Slope: (3 in 12 to 6 in 12)</b>
<b>Double Lock Standing Seam:</b>	 Air Z or Enkamat 7008 or 7010
<b>Angle Lock Standing Seam:</b>	This application is not recommended by RHEINZINK.

1. A roof with a pitch of 3 in 12 to 6 in 12 is a mid slope roof.
2. On a mid slope roofs, breathable membranes are appropriate. High temperature peel and stick self adhesive membranes are recommended as the underlayment at the eaves, rakes, hips, ridges, valleys and around penetrations such as chimneys, soil pipes, skylights, etc. to maintain water tightness.
3. Mid slope standing seam roofs should have cross seams consisting of a water check and an additional soldered cleat 6" from the water check for the engagement of the roof panels or other lengths of valley.
4. Mid slope roofs require the added weather resistance of a double locked seam. Single lock seams are not appropriate for mid slope roofs.
5. In areas of high snow fall, the seam height should be 1-1/2" tall (instead of the standard 1") height for additional weather resistance.
6. The standing seams can be sealed continuously with either butyl sealant or closed cell urethane foam placed on the top of the male leg. The use of urethane foam requires that the height of the male leg be shortened to create enough space for the foam.
7. Mid slope roofs with pitches of 3 in 12 to 6 in 12 require the added protection of drainage mat - RHEINZINK Air-Z or Enkamat (7008 or 7010) by Bonar.
8. Attachment clips and their associated fasteners for mid slope standing seam roofs should be made of stainless steel.
9. Roof penetrations such as skylights, chimneys, or vents that interrupt the seams constitute the most vulnerable part of any standing seam roof. These areas must be detailed carefully with apron flashings with sufficient overlap lengths, capillary breaks, and water checks. Consult your RHEINZINK representative for advice on proper details for these conditions.
10. Prevent water from getting under the metal by either bread panning the panel ends at ridges and roof / wall intersections or by some other means of a closure.
11. Terminate eave ends of panels by leaving the underside of the eave hook horizontal to facilitate drainage of leakage or condensation.
12. All roof installations require Air-Z or Enkamat (7008 or 7010).

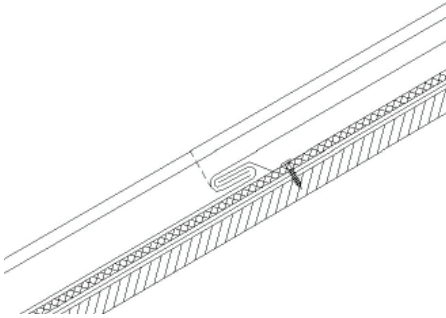

<b>Roofing Application:</b>	<b>Steep Slope: (&gt; 6 in 12)</b>
<b>Double Lock Standing Seam:</b>	 Air Z or Enkamat 7008 or 7010
<b>Angle Lock Standing Seam:</b>	

1. A roof with a pitch of 6 in 12 or greater is a steep slope roof.
2. On steep slope roofs, breathable membranes are appropriate. High temperature peel and stick self adhesive membranes are recommended as the underlayment at the eaves, rakes, hips, ridges, valleys and around penetrations such as chimneys, soil pipes, skylights, etc. to maintain water tightness.
3. Steep slope standing seam roofs can have cross seams consisting of single hook seam. This also applies to valleys.
4. Steep slope roofs can either be single locked or double locked.
5. In areas of high snow fall, the seam height should be 1-1/2" tall (instead of the standard 1") height for additional weather resistance.
6. The standing seams can be sealed continuously with either butyl sealant or closed cell urethane foam placed on the top of the male leg. The use of urethane foam requires that the height of the male leg be shortened to create enough space for the foam.
7. Steep slope roofs with pitches of 6 in 12 or greater require the added protection of drainage mat - RHEINZINK Air-Z or Enkamat (7008 or 7010) by Bonar.
8. Attachment clips and their associated fasteners for steep slope standing seam roofs can be made of stainless steel.
9. Roof penetrations such as skylights, chimneys, or vents that interrupt the seams constitute the most vulnerable part of any standing seam roof. These areas must be detailed carefully with apron flashings with sufficient overlap lengths, capillary breaks, and water checks. Consult a RHEINZINK representative for advice on proper details for these conditions.
10. Prevent water from getting under the metal by either bread panning the panel ends at ridges and roof / wall intersections or by some other means of a closure.
11. Terminate eave ends of panels by leaving the underside of the eave hook horizontal to facilitate drainage of leakage or condensation.
12. All roof installations require Air-Z or Enkamat (7008 or 7010).

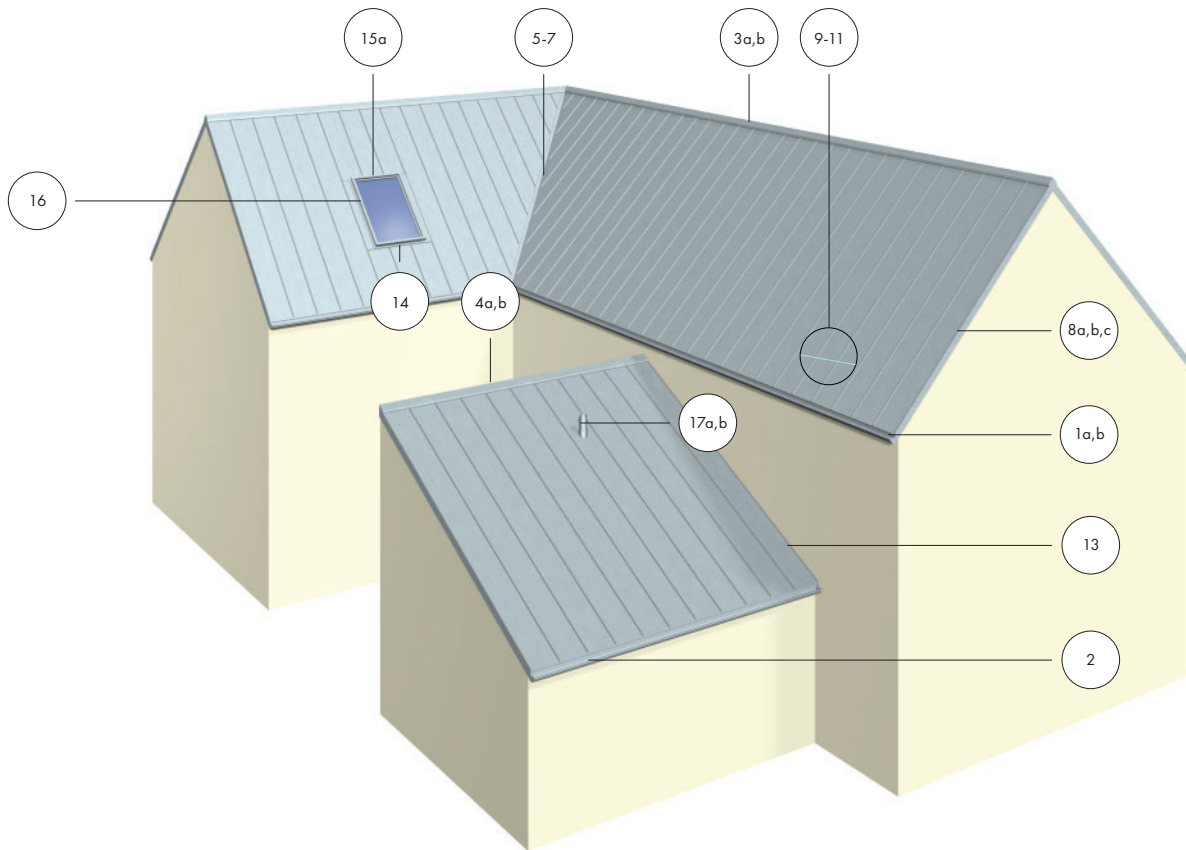

### Standing Seam Roof Details

#### Standard

- SSR-1a - Eave Edge with Gutter
- SSR-2 - Built-In Gutter Detail
- SSR-3a - Ridge / Hip Detail - Option 1
- SSR-3b - Ridge / Hip Detail - Option 2
- SSR-4a - Mono Pitch Ridge Detail - Option 1
- SSR-5 - Steep Slope Valley Detail
- SSR-6 - Mid Slope Valley Detail
- SSR-7 - Low Slope Valley Detail
- SSR-8a - Rake Edge Detail - Option 1
- SSR-8b - Rake Edge Detail - Option 2
- SSR-8c - Rake Edge Detail - Option 3
- SSR-9 - Steep Slope Cross Joint Detail
- SSR-10 - Mid Slope Cross Joint Detail
- SSR-11 - Low Slope Cross Joint Detail
- SSR-12a - Roof to Wall Transition Detail - Option 1
- SSR-13 - Sidewall Detail
- SSR-14 - Skylight Sill Detail
- SSR-15 - Skylight Head Detail
- SSR-16 - Skylight Jamb Detail
- SSR-17a - Vent Pipe Penetration Detail - Option 1
- SSR-17b - Vent Pipe Penetration Detail - Option 2
- SSR-18 - Panel Profile & Clip Detail

#### Custom Details

- SSR-1b - Eave Edge with Without Gutter
- SSR-4b - Mono Pitch Ridge Detail - Option 2
- SSR-12b - Roof to Wall Transition Detail - Option 2

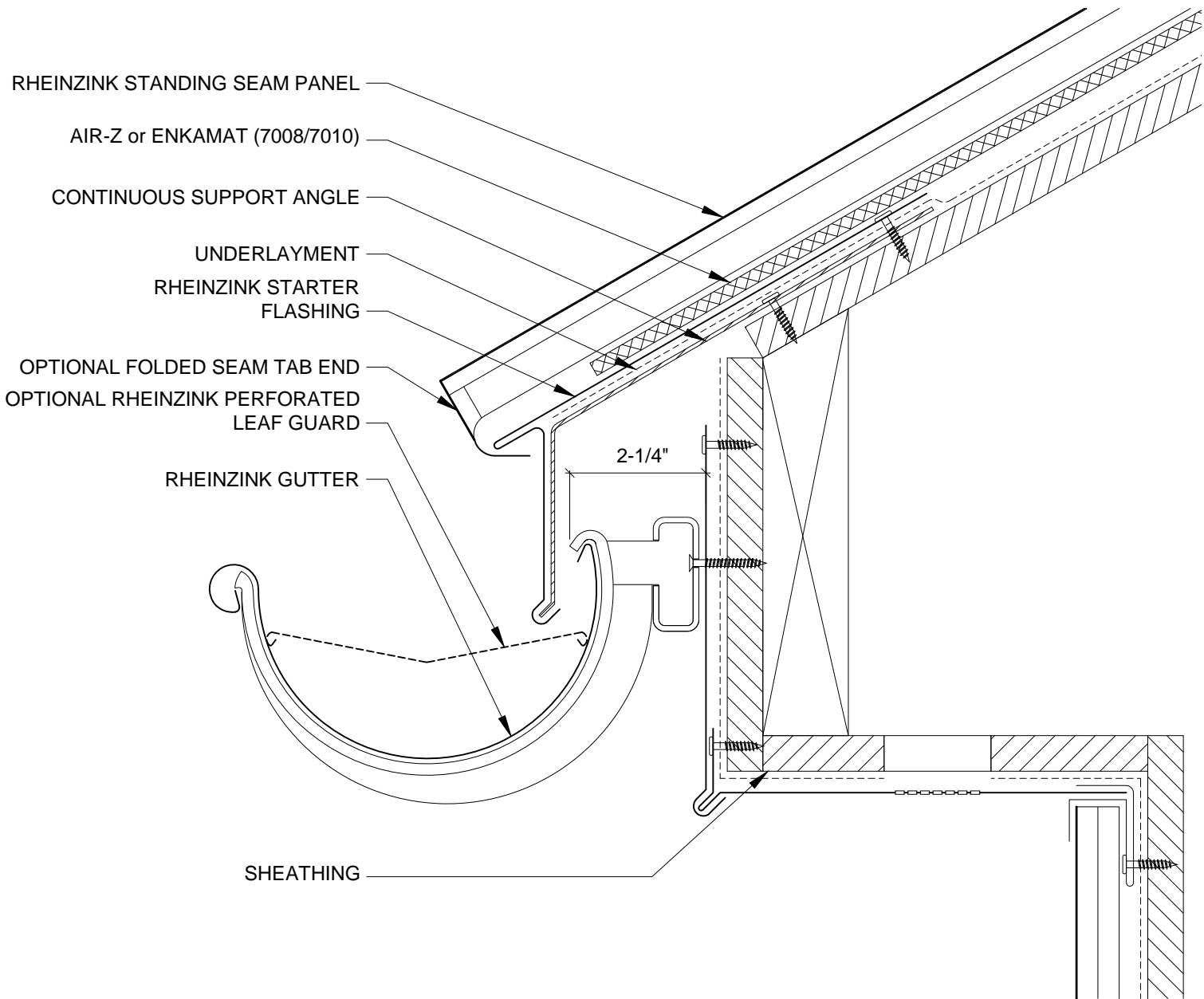

**NOTES:**

1. STANDING SEAM PANELS REQUIRE A MIN. OF 5/8:12 SLOPE.
2. STANDING SEAM PANEL SYSTEMS REQUIRE RHEINZINK PROROOING OR AIR-Z OR ENKAMAT (7008 OR 7010); SEE REQUIREMENTS BASED ON SLOPE.
3. RHEINZINK RECOMMENDS STAINLESS STEEL FASTENERS AND CLIPS.

	
96F Commerce Way Woburn, MA 01801 T: 781.729.0812 Website: www.rheinzink.com E-mail: info@rheinzink.com	
INFORMATION AND DETAILS HEREIN ARE ONLY A BASELINE FOR SYSTEM DESIGN AND INSTALLATION. MODIFICATION TO MEET PROJECT REQUIREMENTS IS THE RESPONSIBILITY OF THE DESIGNER AND ARCHITECT. RHEINZINK AMERICA STAFF ARE AVAILABLE TO ASSIST THE DESIGNER AND ARCHITECT IN THIS PROCESS. RHEINZINK AMERICA MAKES NO REPRESENTATIONS AND WARRANTIES OTHER THAN THOSE EXPRESSED HEREIN.	
PROJECT:	STANDING SEAM ROOF DETAILS
DATE:	11-2011
DRAWING TITLE:	EAVE EDGE - WITH GUTTER - OPT. 1
SCALE:	N.T.S.
COPYRIGHT RESERVED. THIS DRAWING REMAINS THE PROPERTY OF RHEINZINK.	SHEET: SSR-1a



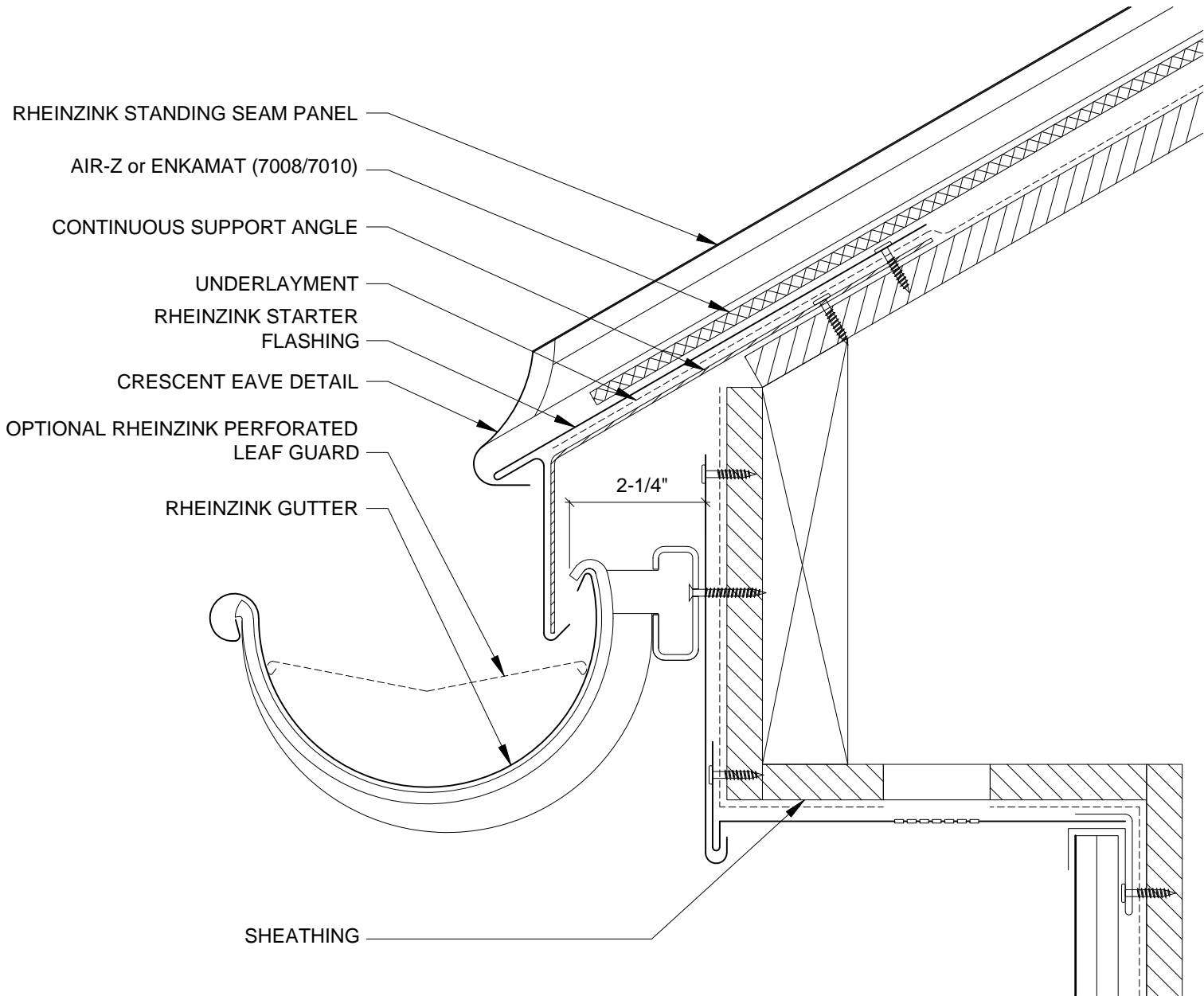

**NOTES:**

1. STANDING SEAM PANELS REQUIRE A MIN. OF 5/8:12 SLOPE.
2. STANDING SEAM PANEL SYSTEMS REQUIRE RHEINZINK PROROOING OR AIR-Z OR ENKAMAT (7008 OR 7010); SEE REQUIREMENTS BASED ON SLOPE.
3. RHEINZINK RECOMMENDS STAINLESS STEEL FASTENERS AND CLIPS.



96F Commerce Way Woburn, MA 01801 T: 781.729.0812  
 Website: www.rheinzink.com E-mail: info@rheinzink.com

INFORMATION AND DETAILS HEREIN ARE ONLY A BASELINE FOR SYSTEM DESIGN AND INSTALLATION. MODIFICATION TO MEET PROJECT REQUIREMENTS IS THE RESPONSIBILITY OF THE DESIGNER AND ARCHITECT. RHEINZINK AMERICA STAFF ARE AVAILABLE TO ASSIST THE DESIGNER AND ARCHITECT IN THIS PROCESS. RHEINZINK AMERICA MAKES NO REPRESENTATIONS AND WARRANTIES OTHER THAN THOSE EXPRESSED HEREIN.

PROJECT:	STANDING SEAM ROOF DETAILS	DATE:	11-2011
DRAWING TITLE:	EAVE EDGE - WITH GUTTER - OPT. 2	SCALE:	N.T.S.
COPYRIGHT RESERVED. THIS DRAWING REMAINS THE PROPERTY OF RHEINZINK.		SHEET:	SSR-1b

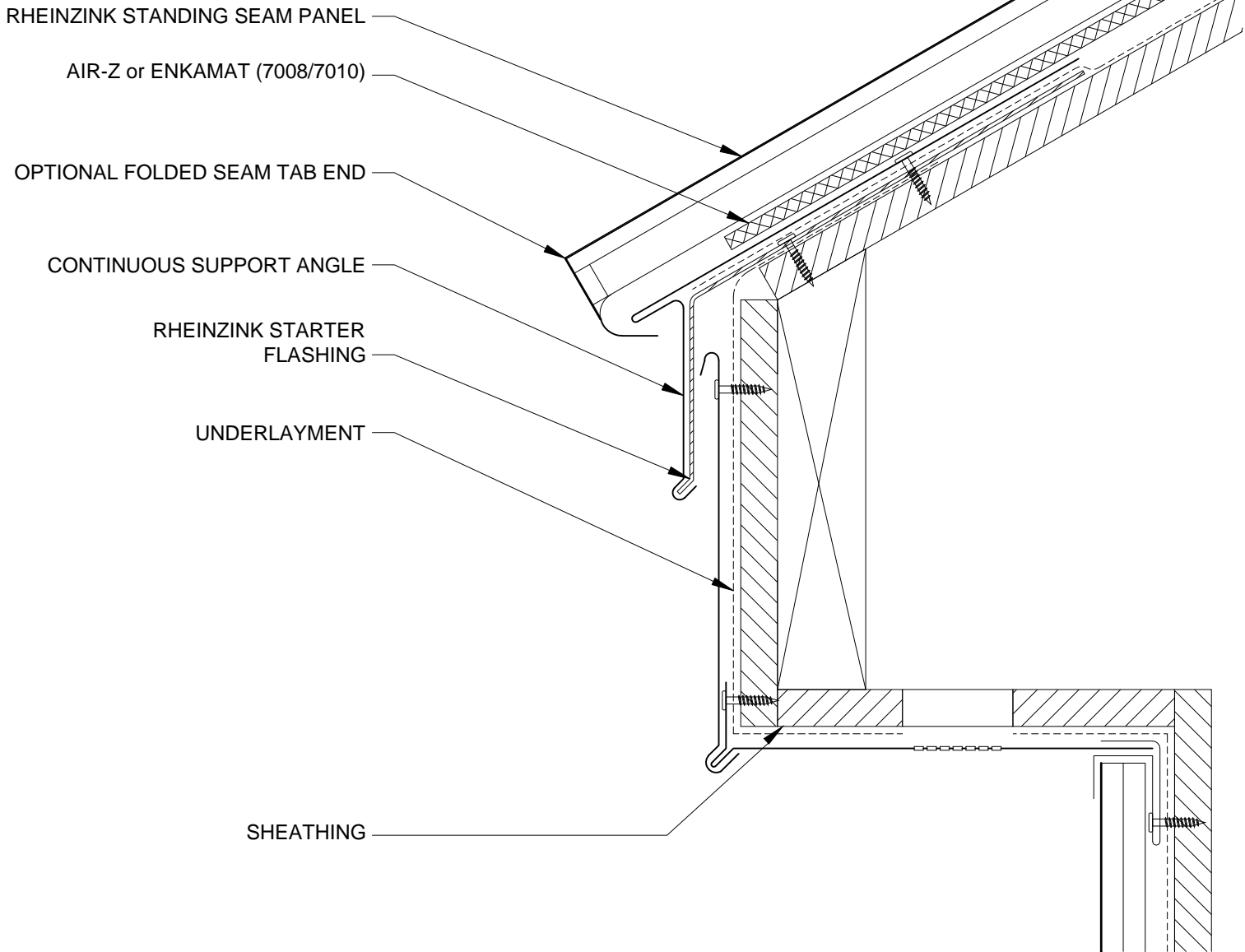

**NOTES:**

1. STANDING SEAM PANELS REQUIRE A MIN. OF 5/8:12 SLOPE.
2. STANDING SEAM PANEL SYSTEMS REQUIRE RHEINZINK PROROOING OR AIR-Z OR ENKAMAT (7008 OR 7010); SEE REQUIREMENTS BASED ON SLOPE.
3. RHEINZINK RECOMMENDS STAINLESS STEEL FASTENERS AND CLIPS.

	
96F Commerce Way Woburn, MA 01801 T: 781.729.0812 Website: www.rheinznk.com E-mail: info@rheinznk.com	
INFORMATION AND DETAILS HEREIN ARE ONLY A BASELINE FOR SYSTEM DESIGN AND INSTALLATION. MODIFICATION TO MEET PROJECT REQUIREMENTS IS THE RESPONSIBILITY OF THE DESIGNER AND ARCHITECT. RHEINZINK AMERICA STAFF ARE AVAILABLE TO ASSIST THE DESIGNER AND ARCHITECT IN THIS PROCESS. RHEINZINK AMERICA MAKES NO REPRESENTATIONS AND WARRANTIES OTHER THAN THOSE EXPRESSED HEREIN.	
PROJECT:	STANDING SEAM ROOF DETAILS
DATE:	11-2011
DRAWING TITLE:	EAVE EDGE - WITHOUT GUTTER
SCALE:	N.T.S.
COPYRIGHT RESERVED. THIS DRAWING REMAINS THE PROPERTY OF RHEINZINK.	SHEET: SSR-1c

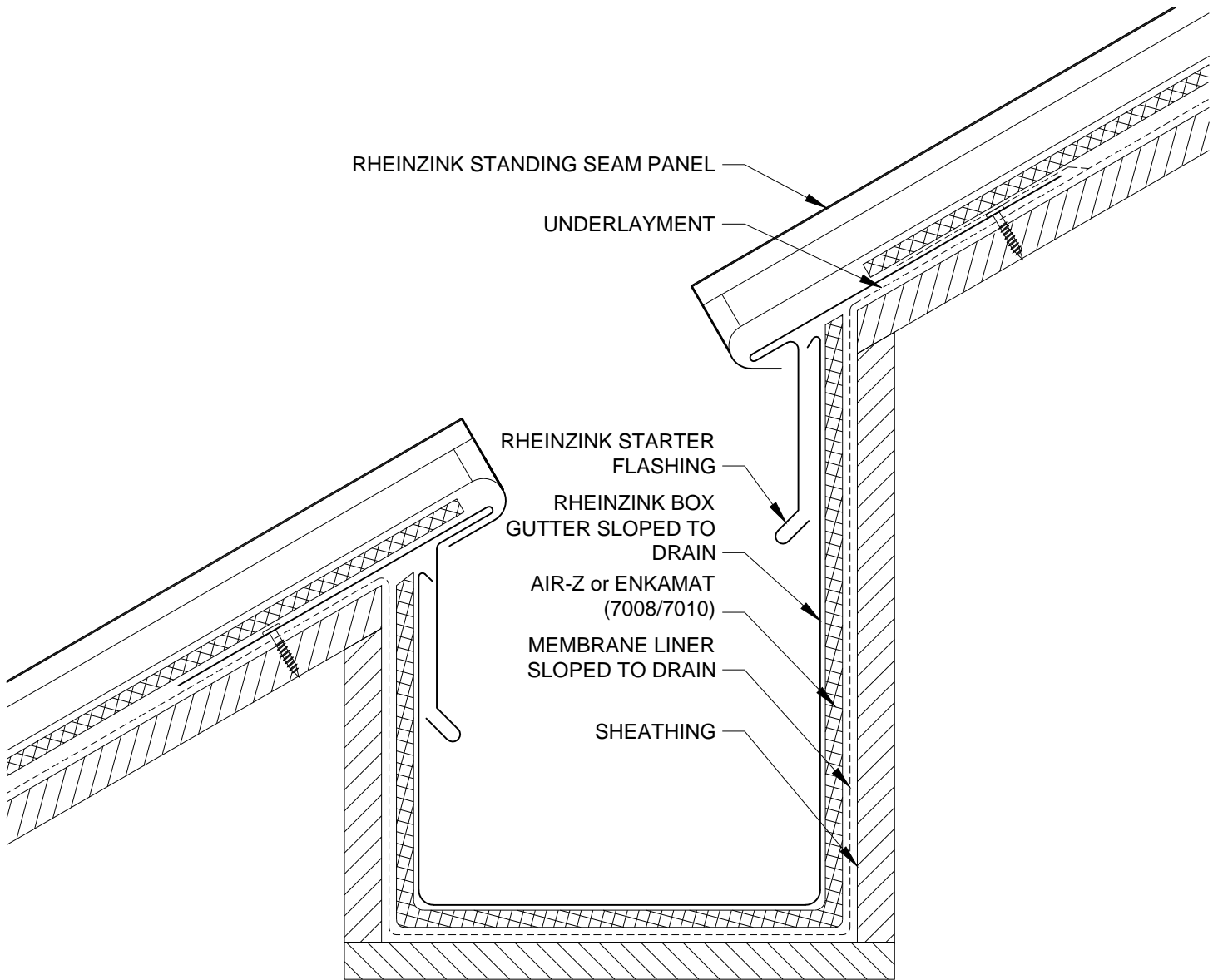

**NOTES:**

1. STANDING SEAM PANELS REQUIRE A MIN. OF 5/8:12 SLOPE.
2. STANDING SEAM PANEL SYSTEMS REQUIRE RHEINZINK PROROOING OR AIR-Z OR ENKAMAT (7008 OR 7010); SEE REQUIREMENTS BASED ON SLOPE.
3. RHEINZINK RECOMMENDS STAINLESS STEEL FASTENERS AND CLIPS.

	
96F Commerce Way Woburn, MA 01801 T: 781.729.0812 Website: www.rheinzink.com E-mail: info@rheinzink.com	
INFORMATION AND DETAILS HEREIN ARE ONLY A BASELINE FOR SYSTEM DESIGN AND INSTALLATION. MODIFICATION TO MEET PROJECT REQUIREMENTS IS THE RESPONSIBILITY OF THE DESIGNER AND ARCHITECT. RHEINZINK AMERICA STAFF ARE AVAILABLE TO ASSIST THE DESIGNER AND ARCHITECT IN THIS PROCESS. RHEINZINK AMERICA MAKES NO REPRESENTATIONS AND WARRANTIES OTHER THAN THOSE EXPRESSED HEREIN.	
PROJECT:	STANDING SEAM ROOF DETAILS
DATE:	11-2011
DRAWING TITLE:	BUILT-IN GUTTER DETAIL - OPT. 1
SCALE:	N.T.S.
COPYRIGHT RESERVED. THIS DRAWING REMAINS THE PROPERTY OF RHEINZINK.	SHEET: SSR-2a

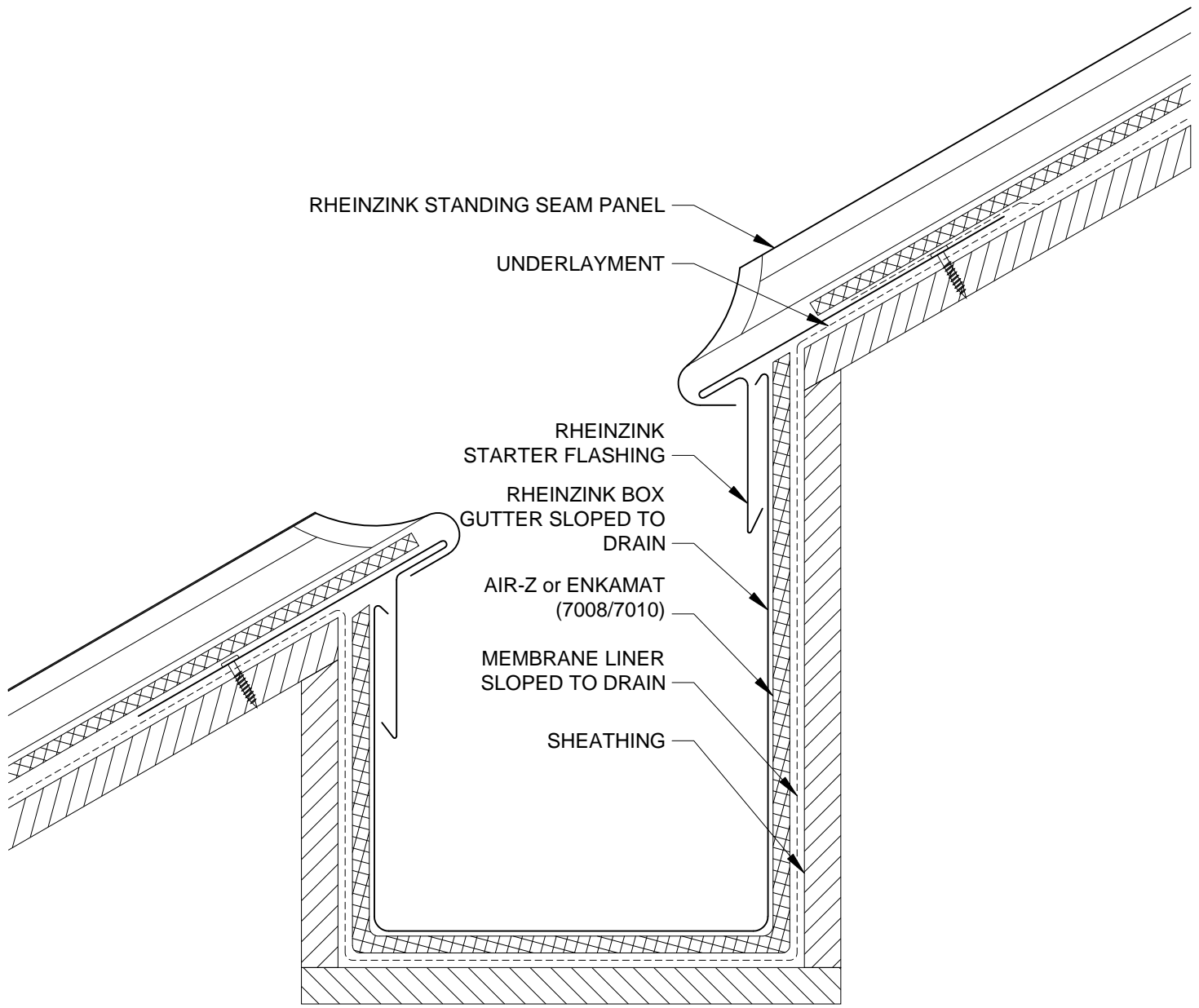

**NOTES:**

1. STANDING SEAM PANELS REQUIRE A MIN. OF 5/8:12 SLOPE.
2. STANDING SEAM PANEL SYSTEMS REQUIRE RHEINZINK PROROOING OR AIR-Z OR ENKAMAT (7008 OR 7010); SEE REQUIREMENTS BASED ON SLOPE.
3. RHEINZINK RECOMMENDS STAINLESS STEEL FASTENERS AND CLIPS.

	
<small>96F Commerce Way Woburn, MA 01801 T: 781.729.0812          Website: www.rheinzink.com E-mail: info@rheinzink.com</small>	
<small>INFORMATION AND DETAILS HEREIN ARE ONLY A BASELINE FOR SYSTEM DESIGN AND INSTALLATION. MODIFICATION TO MEET PROJECT REQUIREMENTS IS THE RESPONSIBILITY OF THE DESIGNER AND ARCHITECT. RHEINZINK AMERICA STAFF ARE AVAILABLE TO ASSIST THE DESIGNER AND ARCHITECT IN THIS PROCESS. RHEINZINK AMERICA MAKES NO REPRESENTATIONS AND WARRANTIES OTHER THAN THOSE EXPRESSED HEREIN.</small>	
<small>PROJECT:</small> <b>STANDING SEAM ROOF DETAILS</b>	<small>DATE:</small> <b>11-2011</b>
<small>DRAWING TITLE:</small> <b>BUILT-IN GUTTER DETAIL - OPT. 2</b>	<small>SCALE:</small> <b>N.T.S.</b>
<small>COPYRIGHT RESERVED. THIS DRAWING REMAINS THE PROPERTY OF RHEINZINK.</small>	<small>SHEET:</small> <b>SSR-2b</b>

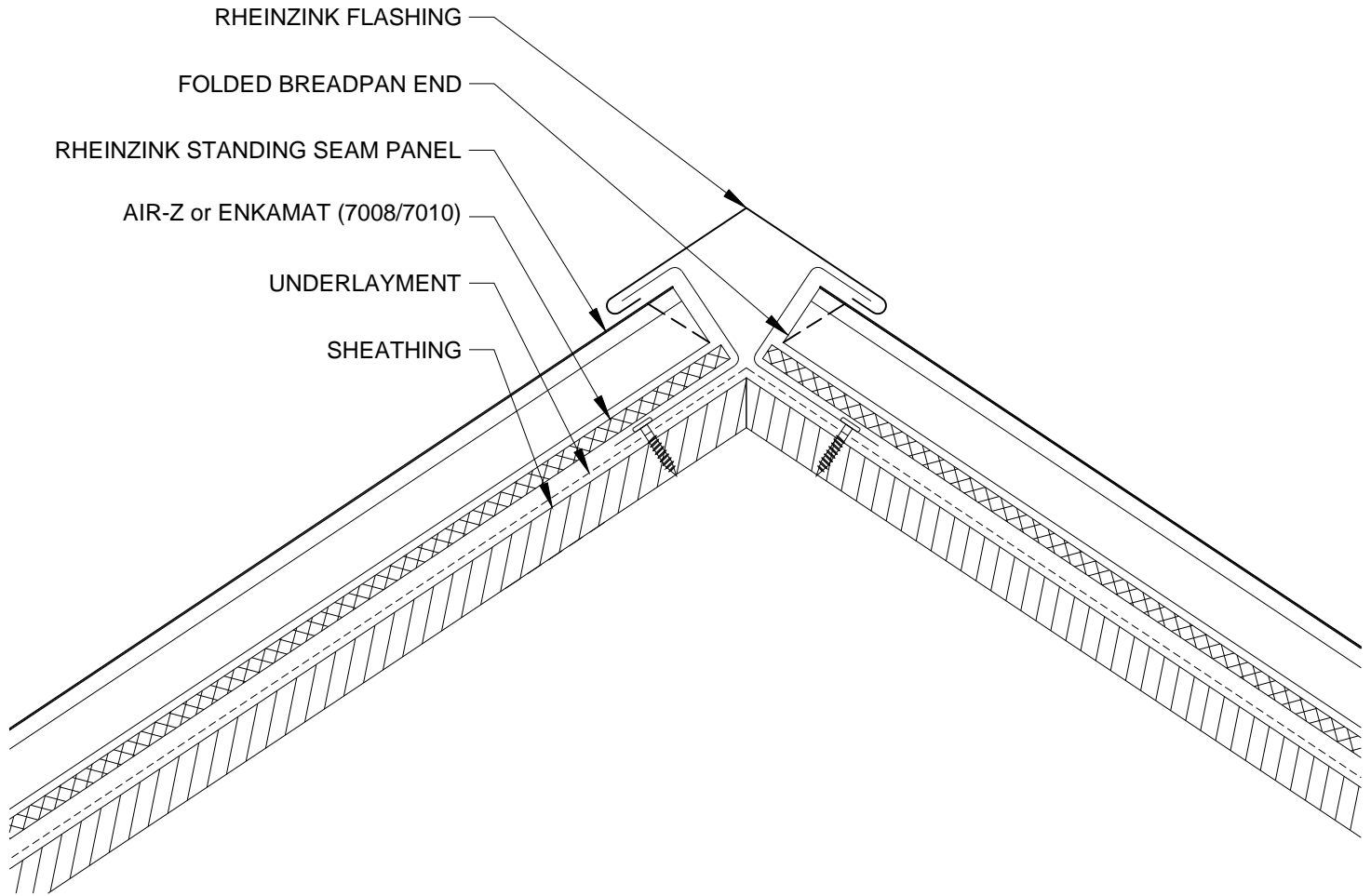

**NOTES:**

1. STANDING SEAM PANELS REQUIRE A MIN. OF 5/8:12 SLOPE.
2. STANDING SEAM PANEL SYSTEMS REQUIRE RHEINZINK PROROOING OR AIR-Z OR ENKAMAT (7008 OR 7010); SEE REQUIREMENTS BASED ON SLOPE.
3. RHEINZINK RECOMMENDS STAINLESS STEEL FASTENERS AND CLIPS.

	
96F Commerce Way Woburn, MA 01801 T: 781.729.0812 Website: www.rheinzink.com E-mail: info@rheinzink.com	
INFORMATION AND DETAILS HEREIN ARE ONLY A BASELINE FOR SYSTEM DESIGN AND INSTALLATION. MODIFICATION TO MEET PROJECT REQUIREMENTS IS THE RESPONSIBILITY OF THE DESIGNER AND ARCHITECT. RHEINZINK AMERICA STAFF ARE AVAILABLE TO ASSIST THE DESIGNER AND ARCHITECT IN THIS PROCESS. RHEINZINK AMERICA MAKES NO REPRESENTATIONS AND WARRANTIES OTHER THAN THOSE EXPRESSED HEREIN.	
PROJECT:	STANDING SEAM ROOF DETAILS
DATE:	11-2011
DRAWING TITLE:	RIDGE / HIP DETAIL - OPT. 1
SCALE:	N.T.S.
COPYRIGHT RESERVED. THIS DRAWING REMAINS THE PROPERTY OF RHEINZINK.	SHEET: SSR-3a

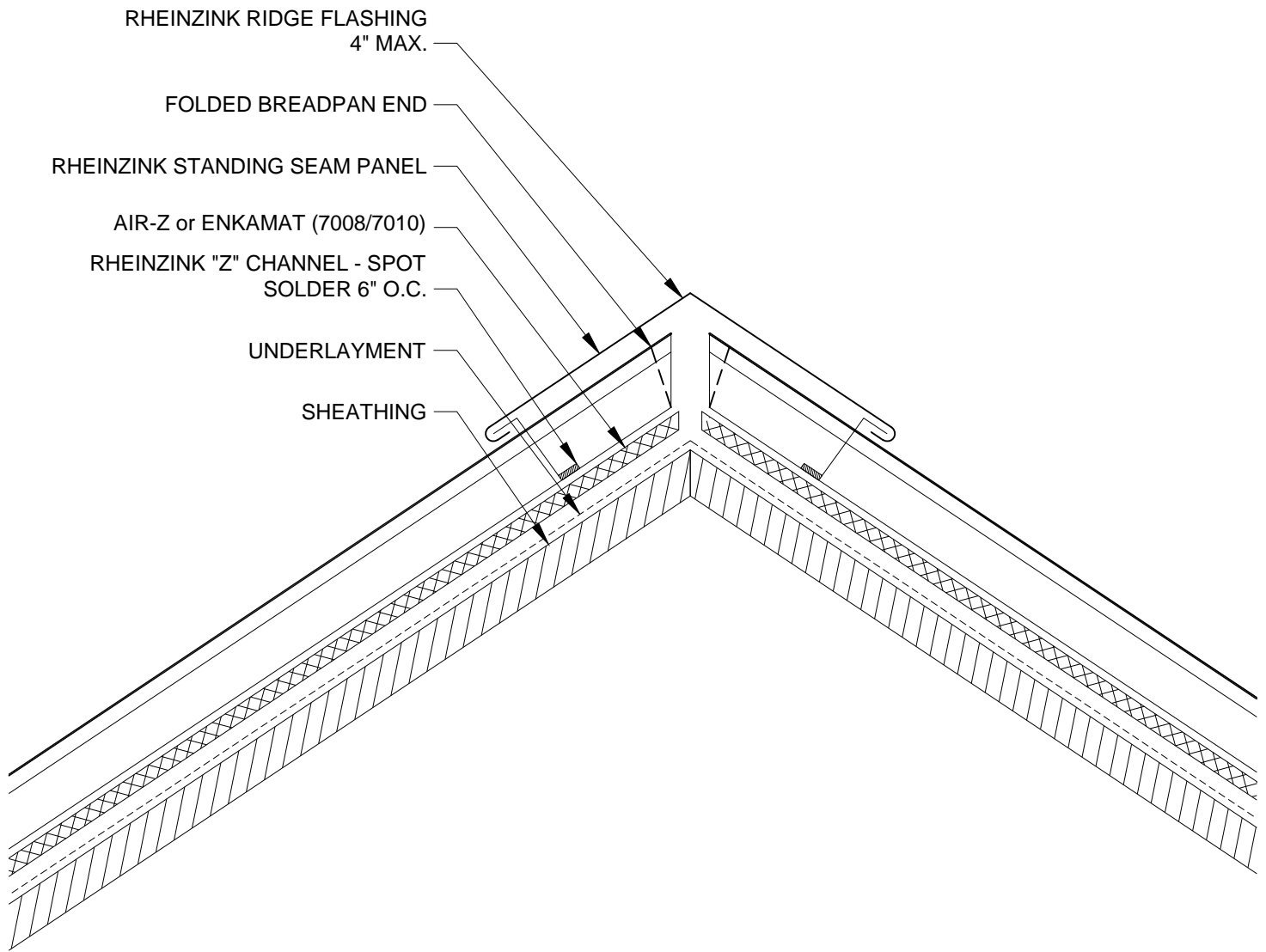

**NOTES:**

1. STANDING SEAM PANELS REQUIRE A MIN. OF 3:12 SLOPE.
2. STANDING SEAM PANEL SYSTEMS REQUIRE RHEINZINK PROROOING OR AIR-Z OR ENKAMAT (7008 OR 7010); SEE REQUIREMENTS BASED ON SLOPE.
3. RHEINZINK RECOMMENDS STAINLESS STEEL FASTENERS AND CLIPS.
4. MAX. 4" - NON-SUPPORTED RIDGE CAP - SUPPORT NEEDED FOR WIDTHS GREATER THAN 4"

	
96F Commerce Way Woburn, MA 01801 T: 781.729.0812 Website: www.rheinzink.com E-mail: info@rheinzink.com	
INFORMATION AND DETAILS HEREIN ARE ONLY A BASELINE FOR SYSTEM DESIGN AND INSTALLATION. MODIFICATION TO MEET PROJECT REQUIREMENTS IS THE RESPONSIBILITY OF THE DESIGNER AND ARCHITECT. RHEINZINK AMERICA STAFF ARE AVAILABLE TO ASSIST THE DESIGNER AND ARCHITECT IN THIS PROCESS. RHEINZINK AMERICA MAKES NO REPRESENTATIONS AND WARRANTIES OTHER THAN THOSE EXPRESSED HEREIN.	
PROJECT:	STANDING SEAM ROOF DETAILS
DATE:	02-2012
DRAWING TITLE:	RIDGE / HIP DETAIL - OPT. 2
SCALE:	N.T.S.
COPYRIGHT RESERVED. THIS DRAWING REMAINS THE PROPERTY OF RHEINZINK.	SHEET: SSR-3b

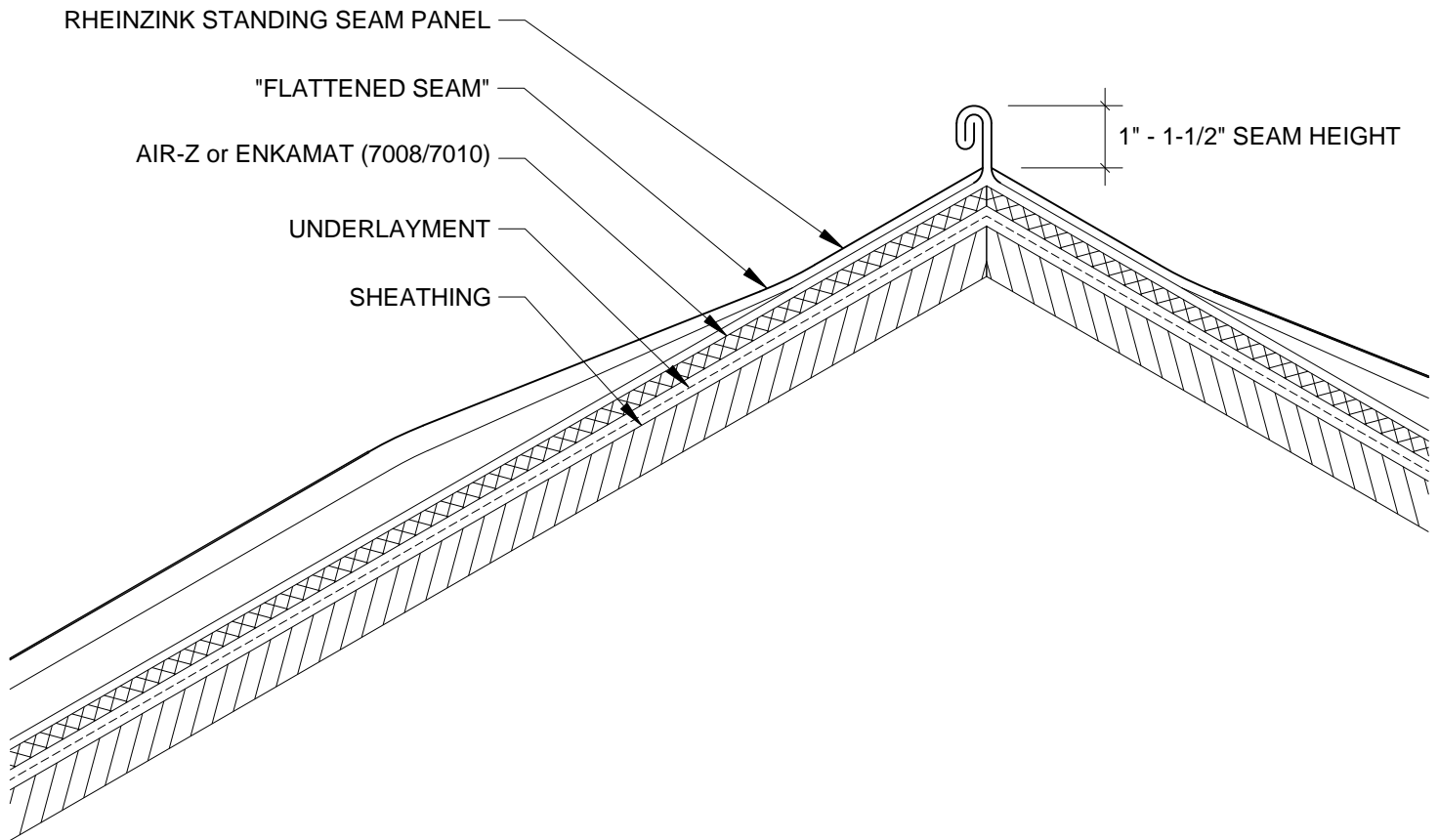

**NOTES:**

1. STANDING SEAM PANELS REQUIRE A MIN. OF 5/8:12 SLOPE.
2. STANDING SEAM PANEL SYSTEMS REQUIRE RHEINZINK PROROOING OR AIR-Z OR ENKAMAT (7008 OR 7010); SEE REQUIREMENTS BASED ON SLOPE.
3. RHEINZINK RECOMMENDS STAINLESS STEEL FASTENERS AND CLIPS.
4. ON LOWER PITCHED ROOF - MIN 2" SEAM ON RIDGE

	
96F Commerce Way Woburn, MA 01801 T: 781.729.0812 Website: www.rheinzink.com E-mail: info@rheinzink.com	
INFORMATION AND DETAILS HEREIN ARE ONLY A BASELINE FOR SYSTEM DESIGN AND INSTALLATION. MODIFICATION TO MEET PROJECT REQUIREMENTS IS THE RESPONSIBILITY OF THE DESIGNER AND ARCHITECT. RHEINZINK AMERICA STAFF ARE AVAILABLE TO ASSIST THE DESIGNER AND ARCHITECT IN THIS PROCESS. RHEINZINK AMERICA MAKES NO REPRESENTATIONS AND WARRANTIES OTHER THAN THOSE EXPRESSED HEREIN.	
PROJECT:	STANDING SEAM ROOF DETAILS
DATE:	10-2011
DRAWING TITLE:	RIDGE / HIP DETAIL - OPT. 3
SCALE:	N.T.S.
COPYRIGHT RESERVED. THIS DRAWING REMAINS THE PROPERTY OF RHEINZINK.	SHEET: SSR-3c

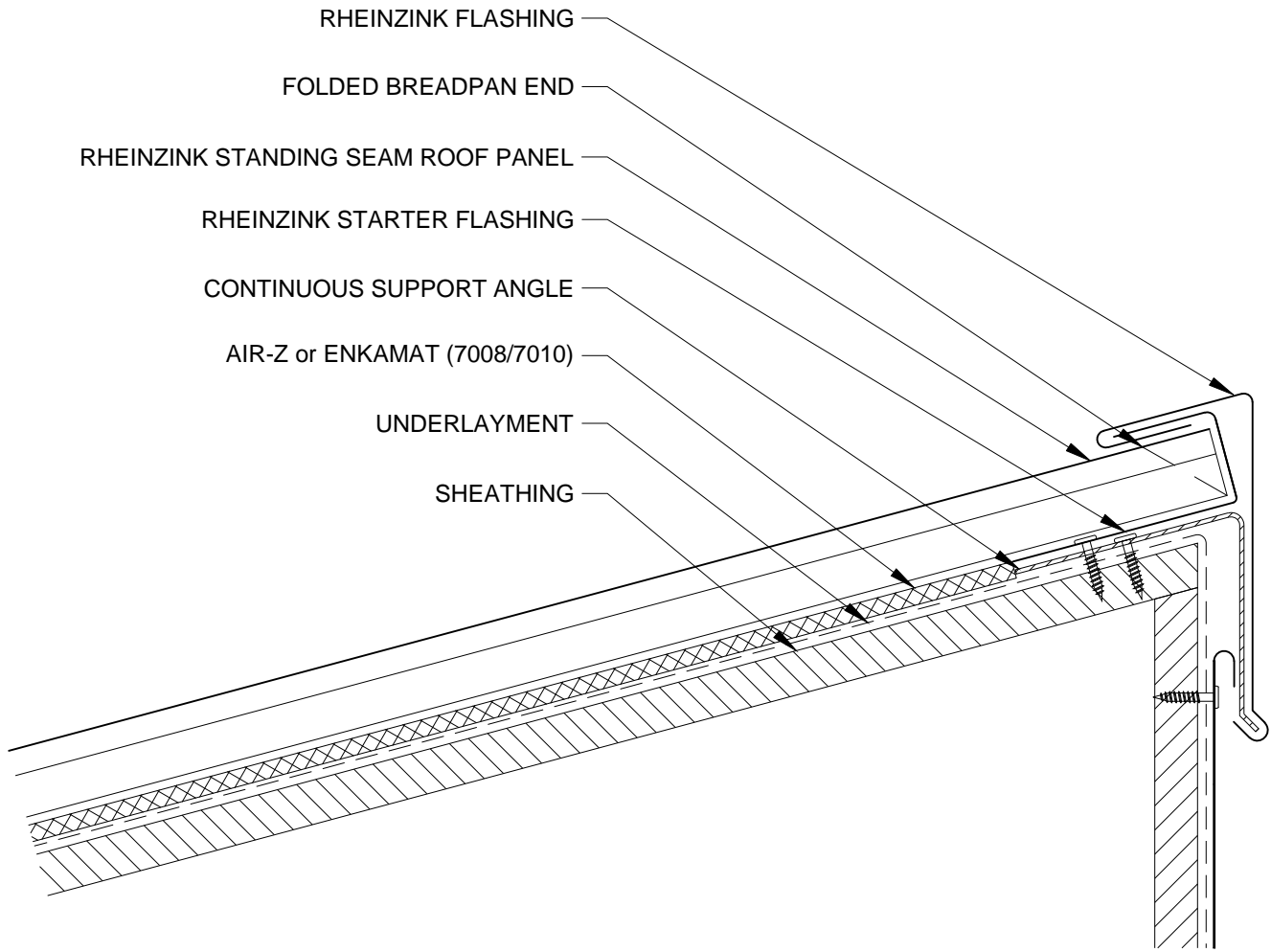

**NOTES:**

1. STANDING SEAM PANELS REQUIRE A MIN. OF 5/8:12 SLOPE.
2. STANDING SEAM PANEL SYSTEMS REQUIRE RHEINZINK PROROOING OR AIR-Z OR ENKAMAT (7008 OR 7010); SEE REQUIREMENTS BASED ON SLOPE.
3. RHEINZINK RECOMMENDS STAINLESS STEEL FASTENERS AND CLIPS.

	
96F Commerce Way Woburn, MA 01801 T: 781.729.0812 Website: www.rheinzink.com E-mail: info@rheinzink.com	
INFORMATION AND DETAILS HEREIN ARE ONLY A BASELINE FOR SYSTEM DESIGN AND INSTALLATION. MODIFICATION TO MEET PROJECT REQUIREMENTS IS THE RESPONSIBILITY OF THE DESIGNER AND ARCHITECT. RHEINZINK AMERICA STAFF ARE AVAILABLE TO ASSIST THE DESIGNER AND ARCHITECT IN THIS PROCESS. RHEINZINK AMERICA MAKES NO REPRESENTATIONS AND WARRANTIES OTHER THAN THOSE EXPRESSED HEREIN.	
PROJECT:	<b>STANDING SEAM ROOF DETAILS</b>
DATE:	11-2011
DRAWING TITLE:	<b>MONO PITCH RIDGE DETAIL - OPT. 1</b>
SCALE:	N.T.S.
COPYRIGHT RESERVED. THIS DRAWING REMAINS THE PROPERTY OF RHEINZINK.	SHEET: <b>SSR-4a</b>



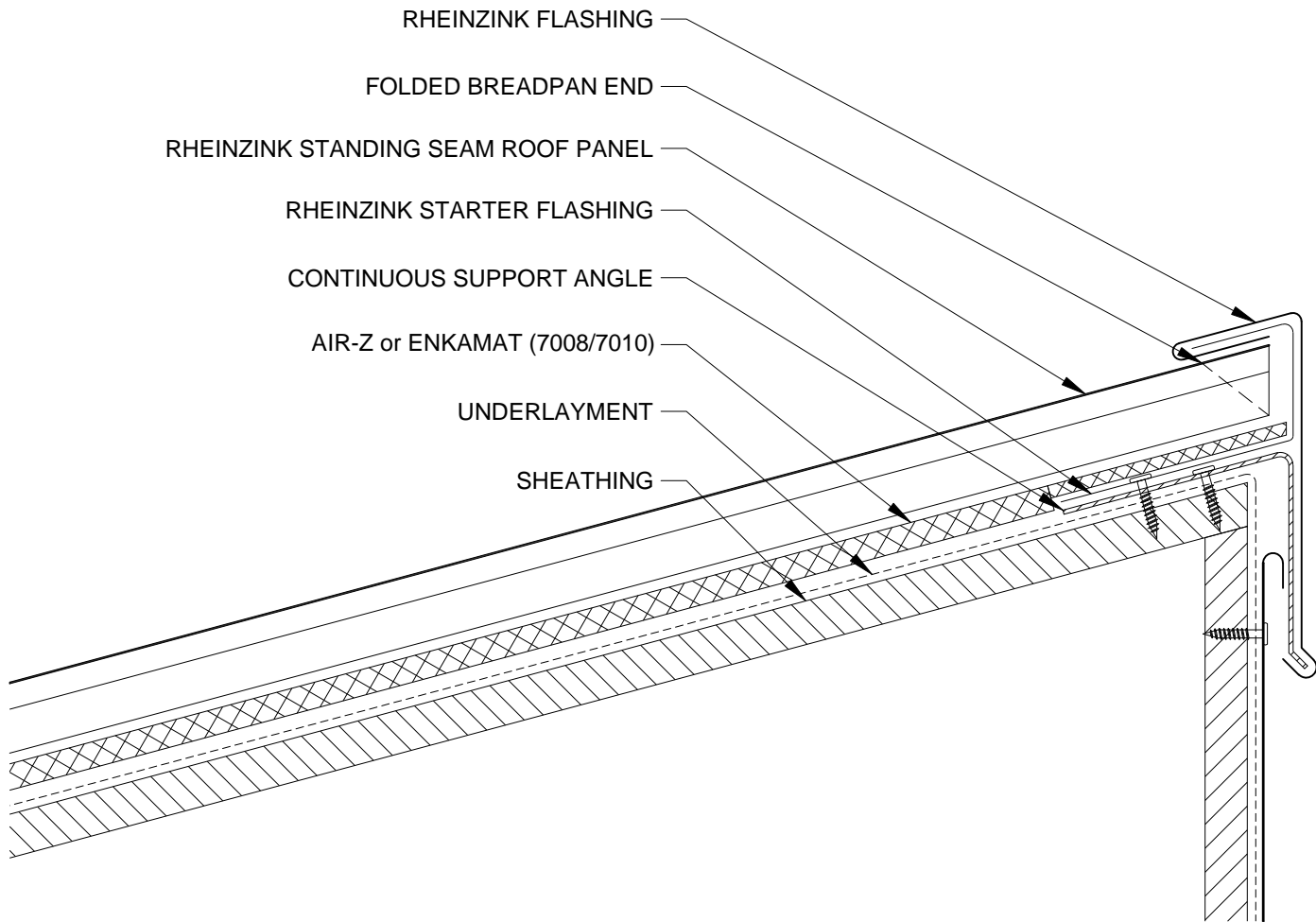

**NOTES:**

1. STANDING SEAM PANELS REQUIRE A MIN. OF 5/8:12 SLOPE.
2. STANDING SEAM PANEL SYSTEMS REQUIRE RHEINZINK PROROOING OR AIR-Z OR ENKAMAT (7008 OR 7010); SEE REQUIREMENTS BASED ON SLOPE.
3. RHEINZINK RECOMMENDS STAINLESS STEEL FASTENERS AND CLIPS.

	
96F Commerce Way Woburn, MA 01801 T: 781.729.0812 Website: www.rheinzink.com E-mail: info@rheinzink.com	
INFORMATION AND DETAILS HEREIN ARE ONLY A BASELINE FOR SYSTEM DESIGN AND INSTALLATION. MODIFICATION TO MEET PROJECT REQUIREMENTS IS THE RESPONSIBILITY OF THE DESIGNER AND ARCHITECT. RHEINZINK AMERICA STAFF ARE AVAILABLE TO ASSIST THE DESIGNER AND ARCHITECT IN THIS PROCESS. RHEINZINK AMERICA MAKES NO REPRESENTATIONS AND WARRANTIES OTHER THAN THOSE EXPRESSED HEREIN.	
PROJECT:	<b>STANDING SEAM ROOF DETAILS</b>
DATE:	<b>11-2011</b>
DRAWING TITLE:	<b>MONO PITCH RIDGE DETAIL - OPT. 2</b>
SCALE:	<b>N.T.S.</b>
COPYRIGHT RESERVED. THIS DRAWING REMAINS THE PROPERTY OF RHEINZINK.	SHEET: <b>SSR-4b</b>

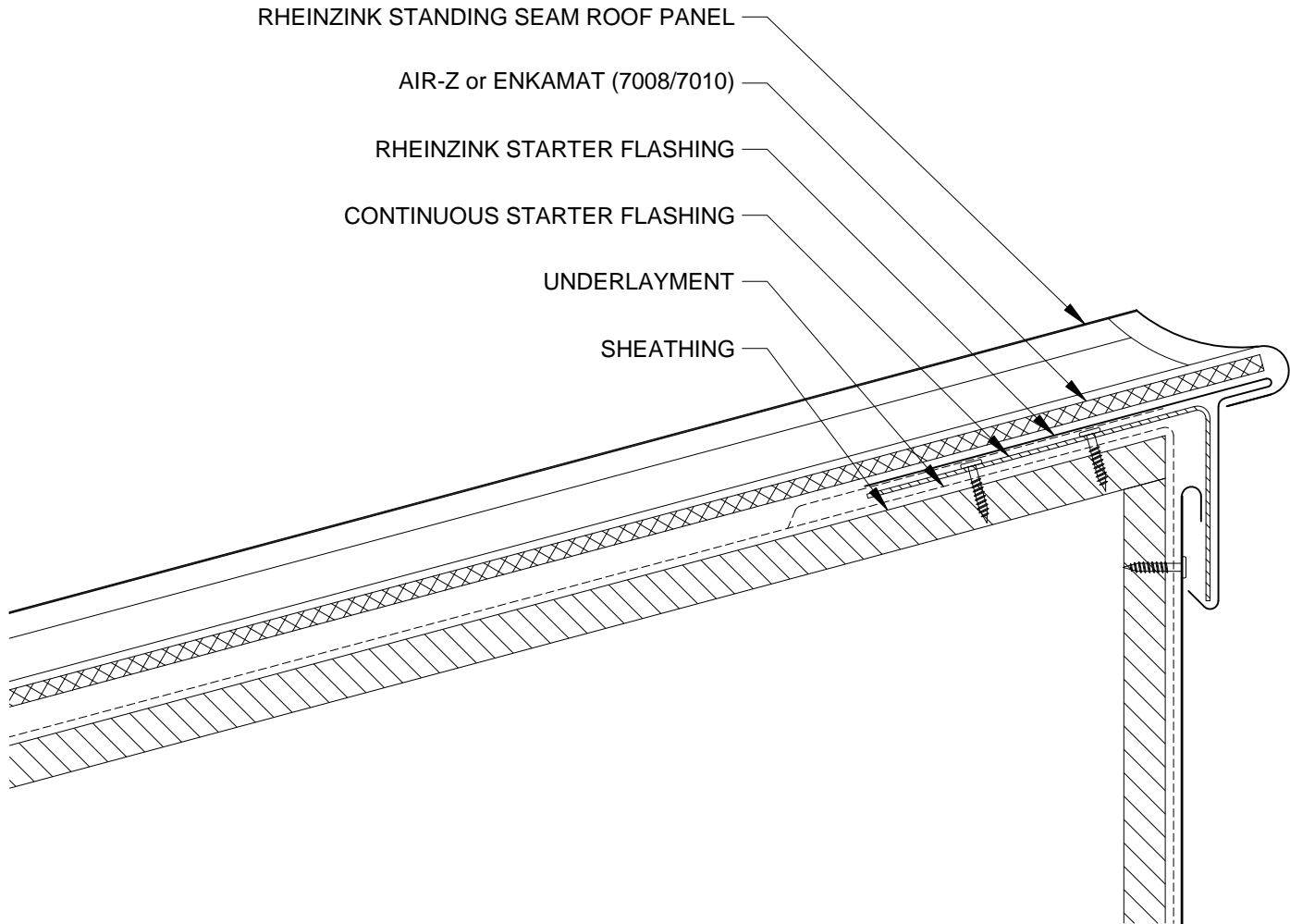

**NOTES:**

1. STANDING SEAM PANELS REQUIRE A MIN. OF 5/8:12 SLOPE.
2. STANDING SEAM PANEL SYSTEMS REQUIRE RHEINZINK PROROOFLING OR AIR-Z OR ENKAMAT (7008 OR 7010); SEE REQUIREMENTS BASED ON SLOPE.
3. RHEINZINK RECOMMENDS STAINLESS STEEL FASTENERS AND CLIPS.
4. THIS DETAIL MAY ONLY BE USED ON A ROOF PITCH OF 4:12 OR GREATER.

 96F Commerce Way Woburn, MA 01801 T: 781.729.0812 Website: www.rheinznk.com E-mail: info@rheinznk.com		
INFORMATION AND DETAILS HEREIN ARE ONLY A BASELINE FOR SYSTEM DESIGN AND INSTALLATION. MODIFICATION TO MEET PROJECT REQUIREMENTS IS THE RESPONSIBILITY OF THE DESIGNER AND ARCHITECT. RHEINZINK AMERICA STAFF ARE AVAILABLE TO ASSIST THE DESIGNER AND ARCHITECT IN THIS PROCESS. RHEINZINK AMERICA MAKES NO REPRESENTATIONS AND WARRANTIES OTHER THAN THOSE EXPRESSED HEREIN.		
PROJECT:	<b>STANDING SEAM ROOF DETAILS</b>	DATE: 03-2012
DRAWING TITLE:	<b>MONO PITCH RIDGE DETAIL - OPT. 3</b>	SCALE: N.T.S.
COPYRIGHT RESERVED. THIS DRAWING REMAINS THE PROPERTY OF RHEINZINK.		SHEET: SSR-4c

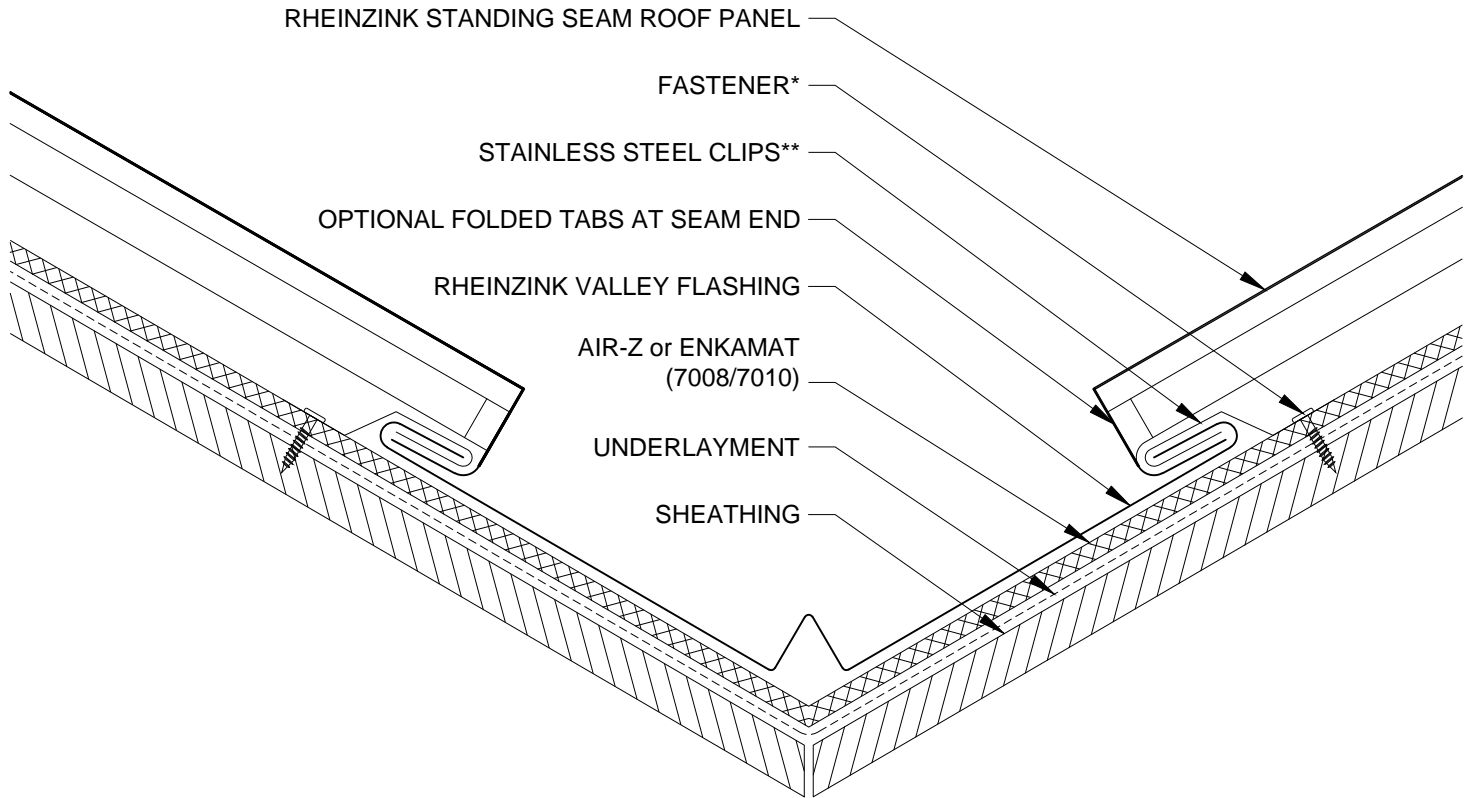

**NOTES:**

1. STANDING SEAM PANELS REQUIRE A MIN. OF 5/8:12 SLOPE.
2. STANDING SEAM PANEL SYSTEMS REQUIRE RHEINZINK PROROOING OR AIR-Z OR ENKAMAT (7008 OR 7010); SEE REQUIREMENTS BASED ON SLOPE.
3. RHEINZINK RECOMMENDS STAINLESS STEEL FASTENERS AND CLIPS.

	
96F Commerce Way Woburn, MA 01801 T: 781.729.0812 Website: www.rheinzink.com E-mail: info@rheinzink.com	
INFORMATION AND DETAILS HEREIN ARE ONLY A BASELINE FOR SYSTEM DESIGN AND INSTALLATION. MODIFICATION TO MEET PROJECT REQUIREMENTS IS THE RESPONSIBILITY OF THE DESIGNER AND ARCHITECT. RHEINZINK AMERICA STAFF ARE AVAILABLE TO ASSIST THE DESIGNER AND ARCHITECT IN THIS PROCESS. RHEINZINK AMERICA MAKES NO REPRESENTATIONS AND WARRANTIES OTHER THAN THOSE EXPRESSED HEREIN.	
PROJECT:	STANDING SEAM ROOF DETAILS
DATE:	08-2011
DRAWING TITLE:	STEEP SLOPE VALLEY DET. - OPT. 1
SCALE:	N.T.S.
COPYRIGHT RESERVED. THIS DRAWING REMAINS THE PROPERTY OF RHEINZINK.	SHEET: SSR-5a

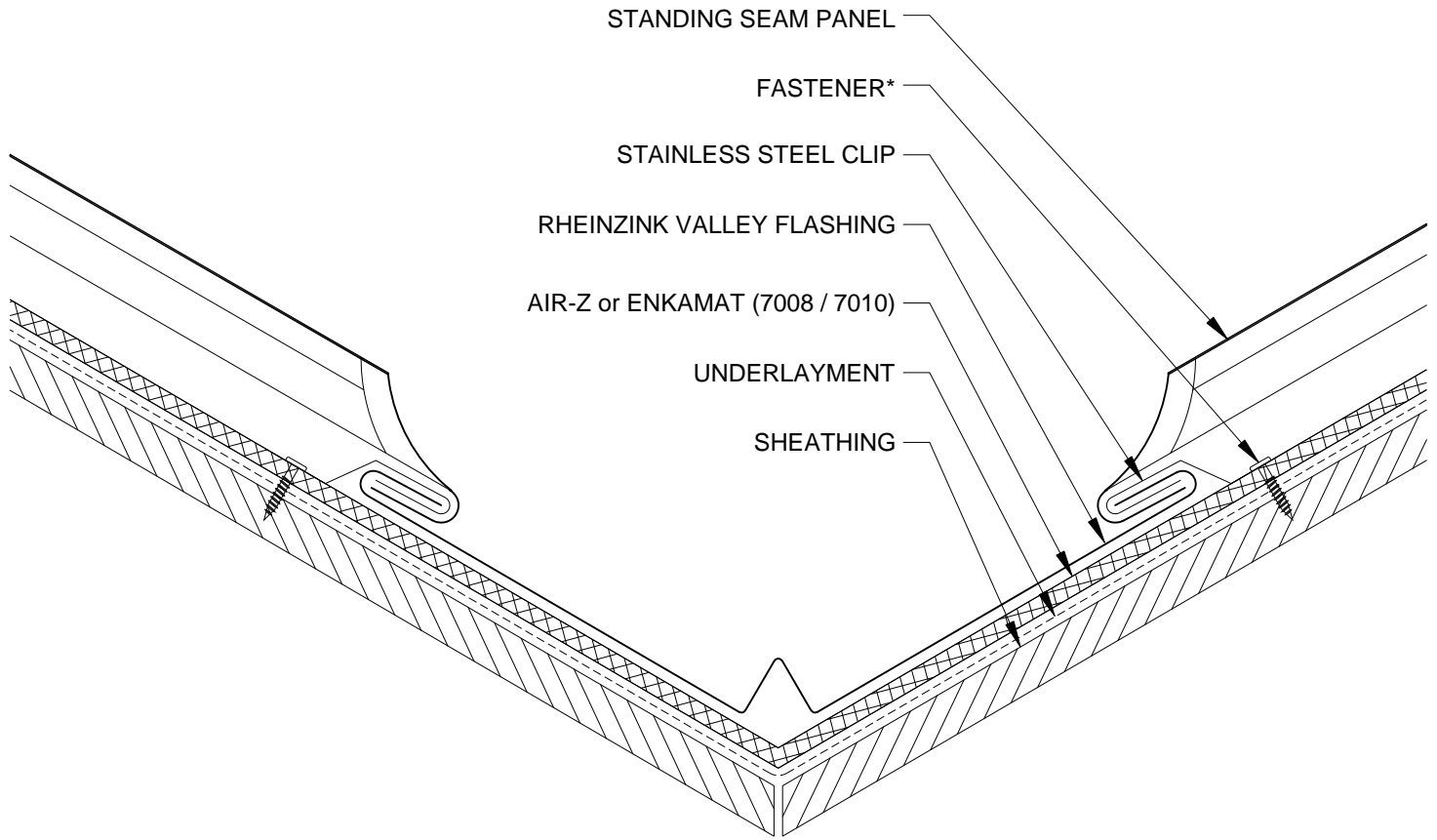

**NOTES:**

1. STANDING SEAM PANELS REQUIRE A MIN. OF 5/8:12 SLOPE.
2. STANDING SEAM PANEL SYSTEMS REQUIRE RHEINZINK PROROOING OR AIR-Z OR ENKAMAT (7008 OR 7010); SEE REQUIREMENTS BASED ON SLOPE.
3. RHEINZINK RECOMMENDS STAINLESS STEEL FASTENERS AND CLIPS.

	
96F Commerce Way Woburn, MA 01801 T: 781.729.0812 Website: www.rheinzink.com E-mail: info@rheinzink.com	
INFORMATION AND DETAILS HEREIN ARE ONLY A BASELINE FOR SYSTEM DESIGN AND INSTALLATION. MODIFICATION TO MEET PROJECT REQUIREMENTS IS THE RESPONSIBILITY OF THE DESIGNER AND ARCHITECT. RHEINZINK AMERICA STAFF ARE AVAILABLE TO ASSIST THE DESIGNER AND ARCHITECT IN THIS PROCESS. RHEINZINK AMERICA MAKES NO REPRESENTATIONS AND WARRANTIES OTHER THAN THOSE EXPRESSED HEREIN.	
PROJECT:	STANDING SEAM ROOF DETAILS
DATE:	08-2011
DRAWING TITLE:	STEEP SLOPE VALLEY DET. - OPT. 2
SCALE:	N.T.S.
COPYRIGHT RESERVED. THIS DRAWING REMAINS THE PROPERTY OF RHEINZINK.	SHEET: SSR-5b

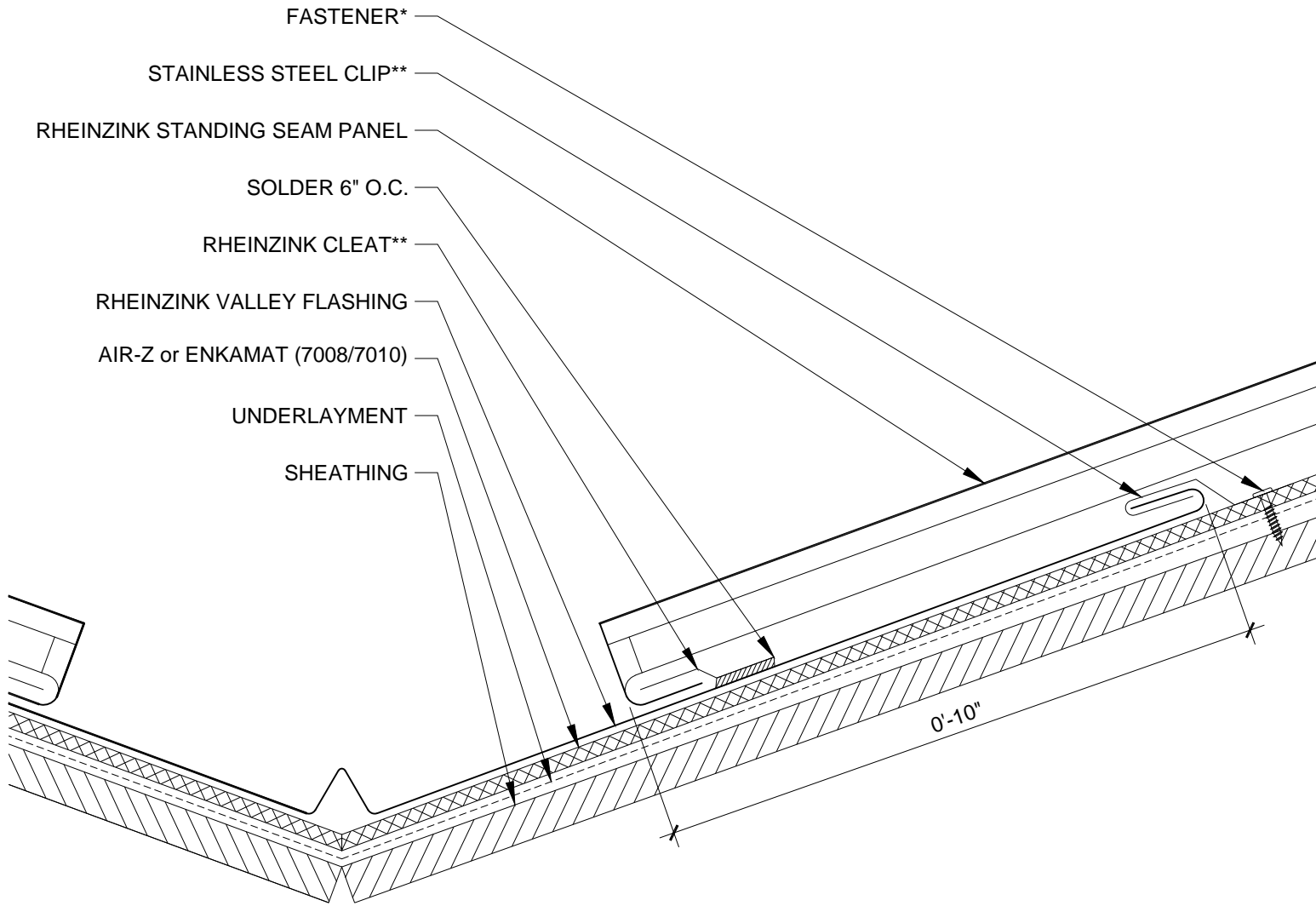

**NOTES:**

1. STANDING SEAM PANELS REQUIRE A MIN. OF 5/8:12 SLOPE.
2. STANDING SEAM PANEL SYSTEMS REQUIRE RHEINZINK PROROOING OR AIR-Z OR ENKAMAT (7008 OR 7010); SEE REQUIREMENTS BASED ON SLOPE.
3. RHEINZINK RECOMMENDS STAINLESS STEEL FASTENERS AND CLIPS.

	
96F Commerce Way Woburn, MA 01801 T: 781.729.0812 Website: www.rheinzink.com E-mail: info@rheinzink.com	
INFORMATION AND DETAILS HEREIN ARE ONLY A BASELINE FOR SYSTEM DESIGN AND INSTALLATION. MODIFICATION TO MEET PROJECT REQUIREMENTS IS THE RESPONSIBILITY OF THE DESIGNER AND ARCHITECT. RHEINZINK AMERICA STAFF ARE AVAILABLE TO ASSIST THE DESIGNER AND ARCHITECT IN THIS PROCESS. RHEINZINK AMERICA MAKES NO REPRESENTATIONS AND WARRANTIES OTHER THAN THOSE EXPRESSED HEREIN.	
PROJECT:	STANDING SEAM ROOF DETAILS
DATE:	08-2011
DRAWING TITLE:	MID SLOPE VALLEY DET. - OPT. 1
SCALE:	N.T.S.
COPYRIGHT RESERVED. THIS DRAWING REMAINS THE PROPERTY OF RHEINZINK.	SHEET: SSR-6a

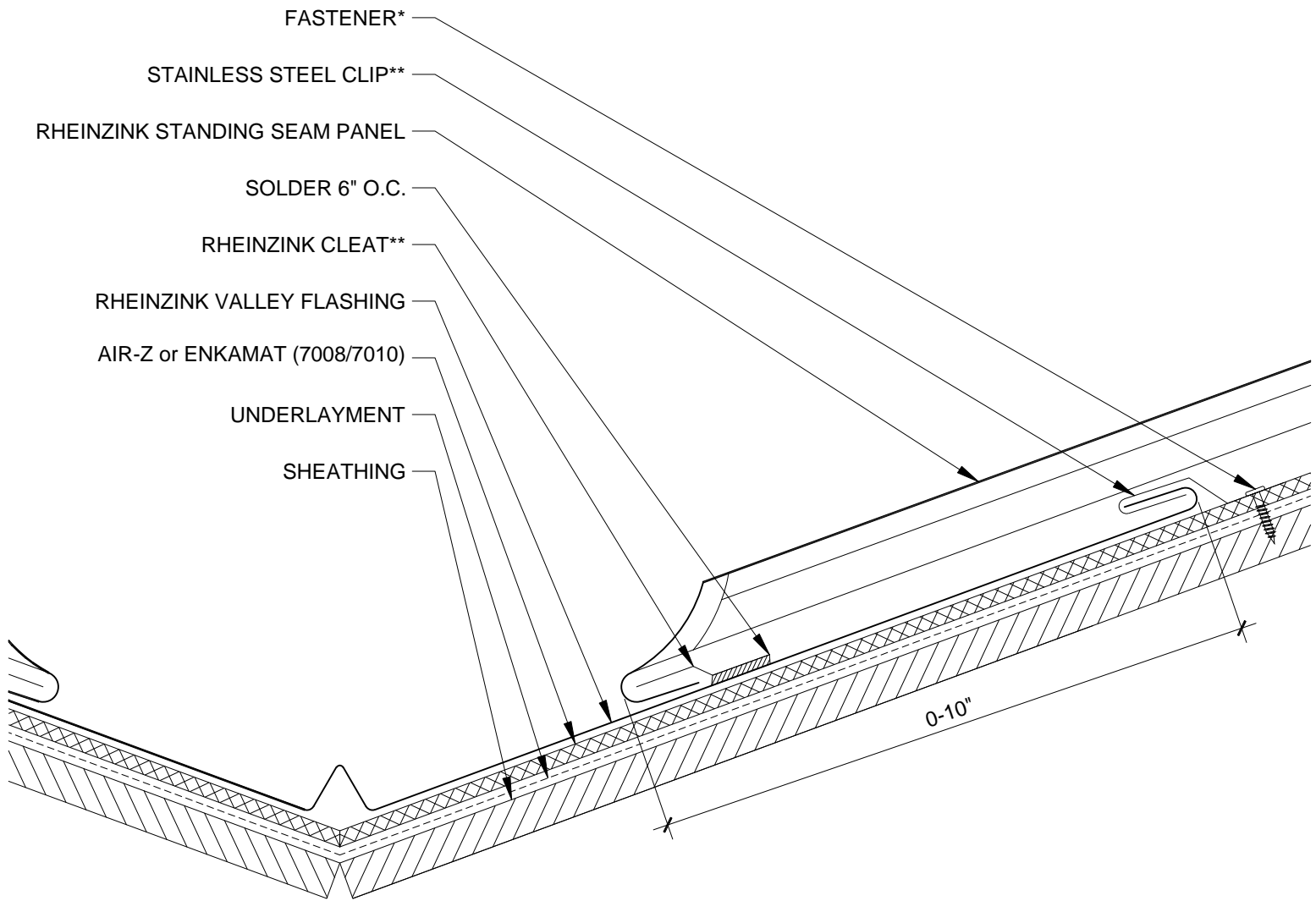

**NOTES:**

1. STANDING SEAM PANELS REQUIRE A MIN. OF 5/8:12 SLOPE.
2. STANDING SEAM PANEL SYSTEMS REQUIRE RHEINZINK PROROOING OR AIR-Z OR ENKAMAT (7008 OR 7010); SEE REQUIREMENTS BASED ON SLOPE.
3. RHEINZINK RECOMMENDS STAINLESS STEEL FASTENERS AND CLIPS.

	
96F Commerce Way Woburn, MA 01801 T: 781.729.0812 Website: www.rheinzink.com E-mail: info@rheinzink.com	
INFORMATION AND DETAILS HEREIN ARE ONLY A BASELINE FOR SYSTEM DESIGN AND INSTALLATION. MODIFICATION TO MEET PROJECT REQUIREMENTS IS THE RESPONSIBILITY OF THE DESIGNER AND ARCHITECT. RHEINZINK AMERICA STAFF ARE AVAILABLE TO ASSIST THE DESIGNER AND ARCHITECT IN THIS PROCESS. RHEINZINK AMERICA MAKES NO REPRESENTATIONS AND WARRANTIES OTHER THAN THOSE EXPRESSED HEREIN.	
PROJECT:	STANDING SEAM ROOF DETAILS
DATE:	08-2011
DRAWING TITLE:	MID SLOPE VALLEY DET. - OPT. 2
SCALE:	N.T.S.
COPYRIGHT RESERVED. THIS DRAWING REMAINS THE PROPERTY OF RHEINZINK.	SHEET: SSR-6b

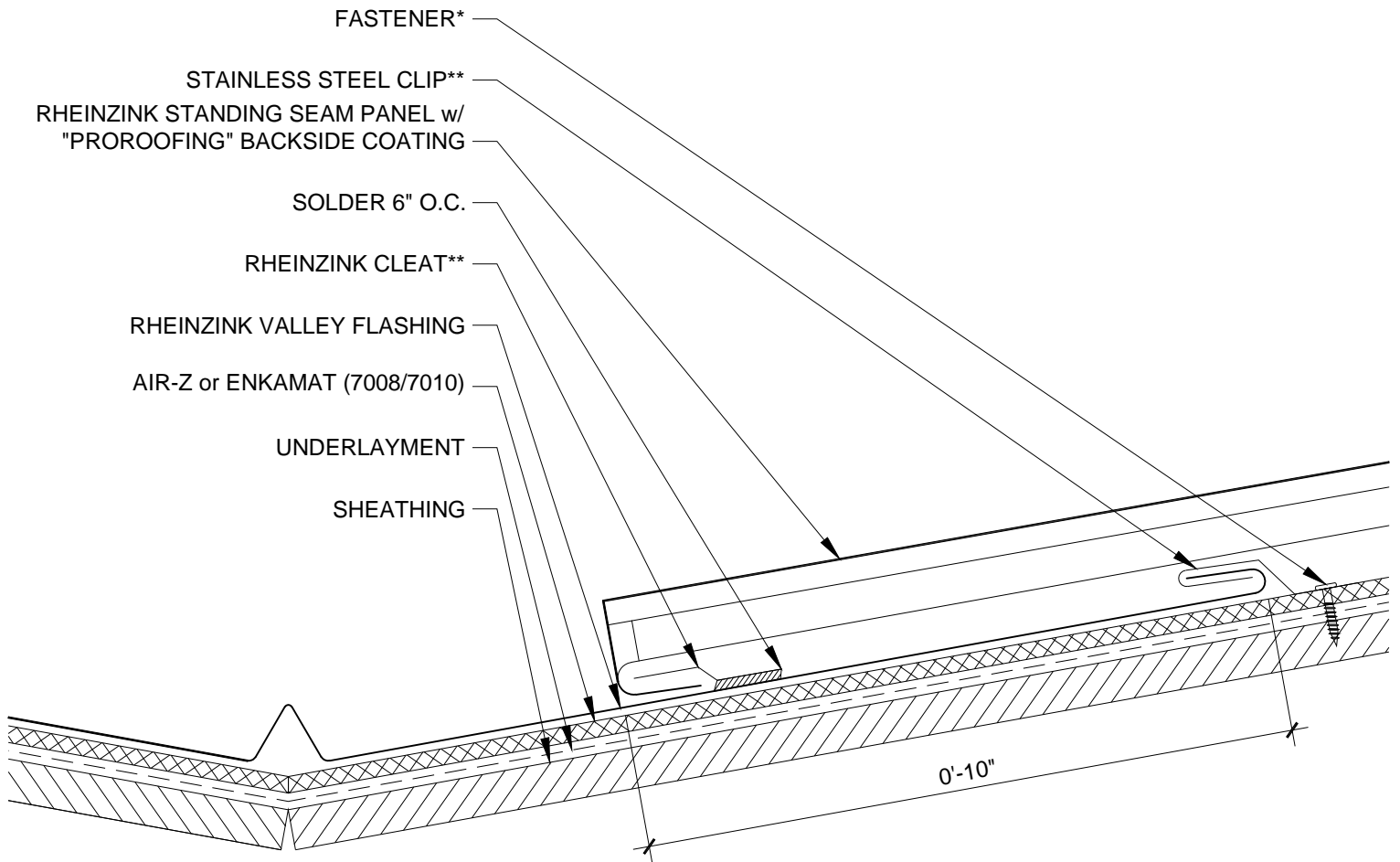

**NOTES:**

1. STANDING SEAM PANELS REQUIRE A MIN. OF 5/8:12 SLOPE.
2. STANDING SEAM PANEL SYSTEMS REQUIRE RHEINZINK PROROOING OR AIR-Z OR ENKAMAT (7008 OR 7010); SEE REQUIREMENTS BASED ON SLOPE.
3. RHEINZINK RECOMMENDS STAINLESS STEEL FASTENERS AND CLIPS.

	
96F Commerce Way Woburn, MA 01801 T: 781.729.0812 Website: www.rheinzink.com E-mail: info@rheinzink.com	
INFORMATION AND DETAILS HEREIN ARE ONLY A BASELINE FOR SYSTEM DESIGN AND INSTALLATION. MODIFICATION TO MEET PROJECT REQUIREMENTS IS THE RESPONSIBILITY OF THE DESIGNER AND ARCHITECT. RHEINZINK AMERICA STAFF ARE AVAILABLE TO ASSIST THE DESIGNER AND ARCHITECT IN THIS PROCESS. RHEINZINK AMERICA MAKES NO REPRESENTATIONS AND WARRANTIES OTHER THAN THOSE EXPRESSED HEREIN.	
PROJECT:	STANDING SEAM ROOF DETAILS
DATE:	08-2011
DRAWING TITLE:	LOW SLOPE VALLEY WALL - OPT. 1
SCALE:	N.T.S.
COPYRIGHT RESERVED. THIS DRAWING REMAINS THE PROPERTY OF RHEINZINK.	SHEET: SSR-7a

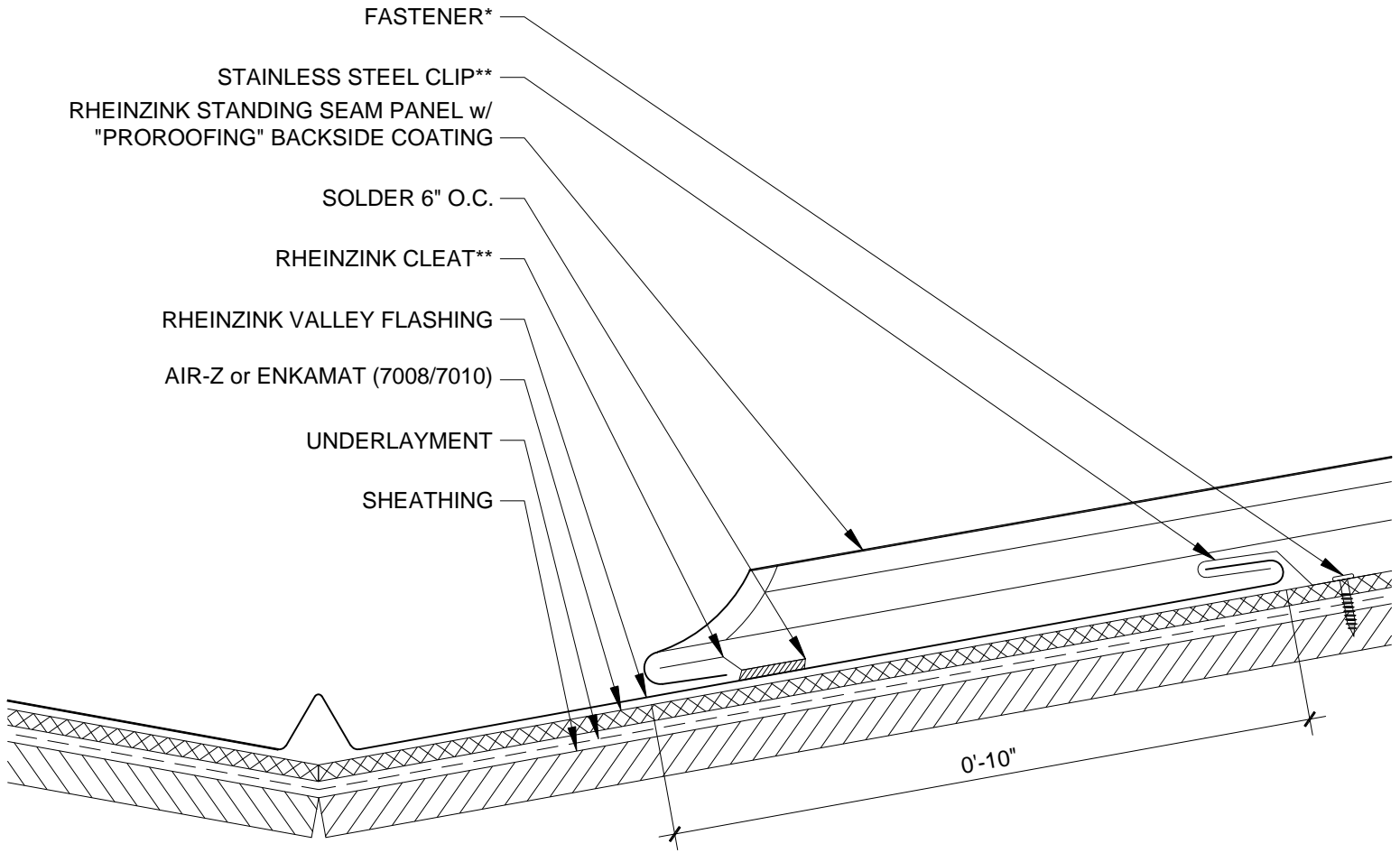

**NOTES:**

1. STANDING SEAM PANELS REQUIRE A MIN. OF 5/8:12 SLOPE.
2. STANDING SEAM PANEL SYSTEMS REQUIRE RHEINZINK PROROOING OR AIR-Z OR ENKAMAT (7008 OR 7010); SEE REQUIREMENTS BASED ON SLOPE.
3. RHEINZINK RECOMMENDS STAINLESS STEEL FASTENERS AND CLIPS.



96F Commerce Way Woburn, MA 01801 T: 781.729.0812  
 Website: www.rheinzink.com E-mail: info@rheinzink.com

INFORMATION AND DETAILS HEREIN ARE ONLY A BASELINE FOR SYSTEM DESIGN AND INSTALLATION. MODIFICATION TO MEET PROJECT REQUIREMENTS IS THE RESPONSIBILITY OF THE DESIGNER AND ARCHITECT. RHEINZINK AMERICA STAFF ARE AVAILABLE TO ASSIST THE DESIGNER AND ARCHITECT IN THIS PROCESS. RHEINZINK AMERICA MAKES NO REPRESENTATIONS AND WARRANTIES OTHER THAN THOSE EXPRESSED HEREIN.

PROJECT:	STANDING SEAM ROOF DETAILS	DATE:	08-2011
DRAWING TITLE:	LOW SLOPE VALLEY WALL - OPT. 1	SCALE:	N.T.S.
COPYRIGHT RESERVED. THIS DRAWING REMAINS THE PROPERTY OF RHEINZINK.		SHEET:	SSR-7b



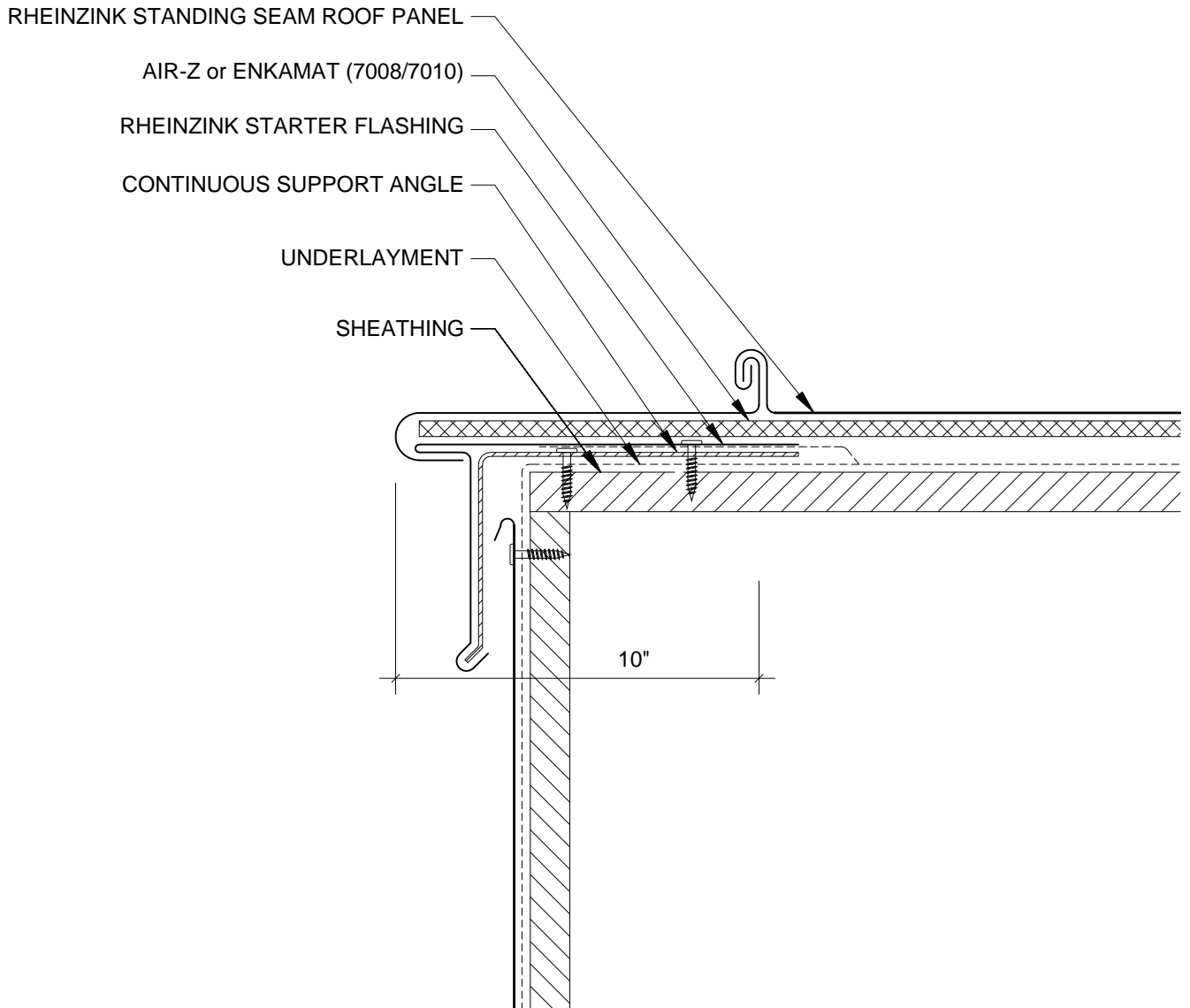

**NOTES:**

1. STANDING SEAM PANELS REQUIRE A MIN. OF 5/8:12 SLOPE.
2. STANDING SEAM PANEL SYSTEMS REQUIRE RHEINZINK PROROOING OR AIR-Z OR ENKAMAT (7008 OR 7010); SEE REQUIREMENTS BASED ON SLOPE.
3. RHEINZINK RECOMMENDS STAINLESS STEEL FASTENERS AND CLIPS.



96F Commerce Way Woburn, MA 01801 T: 781.729.0812  
 Website: www.rheinzink.com E-mail: info@rheinzink.com

INFORMATION AND DETAILS HEREIN ARE ONLY A BASELINE FOR SYSTEM DESIGN AND INSTALLATION. MODIFICATION TO MEET PROJECT REQUIREMENTS IS THE RESPONSIBILITY OF THE DESIGNER AND ARCHITECT. RHEINZINK AMERICA STAFF ARE AVAILABLE TO ASSIST THE DESIGNER AND ARCHITECT IN THIS PROCESS. RHEINZINK AMERICA MAKES NO REPRESENTATIONS AND WARRANTIES OTHER THAN THOSE EXPRESSED HEREIN.

PROJECT:	STANDING SEAM ROOF DETAILS	DATE:	11-2011
DRAWING TITLE:	RAKE EDGE DETAIL - OPT. 1	SCALE:	N.T.S.
COPYRIGHT RESERVED. THIS DRAWING REMAINS THE PROPERTY OF RHEINZINK.		SHEET:	SSR-8a

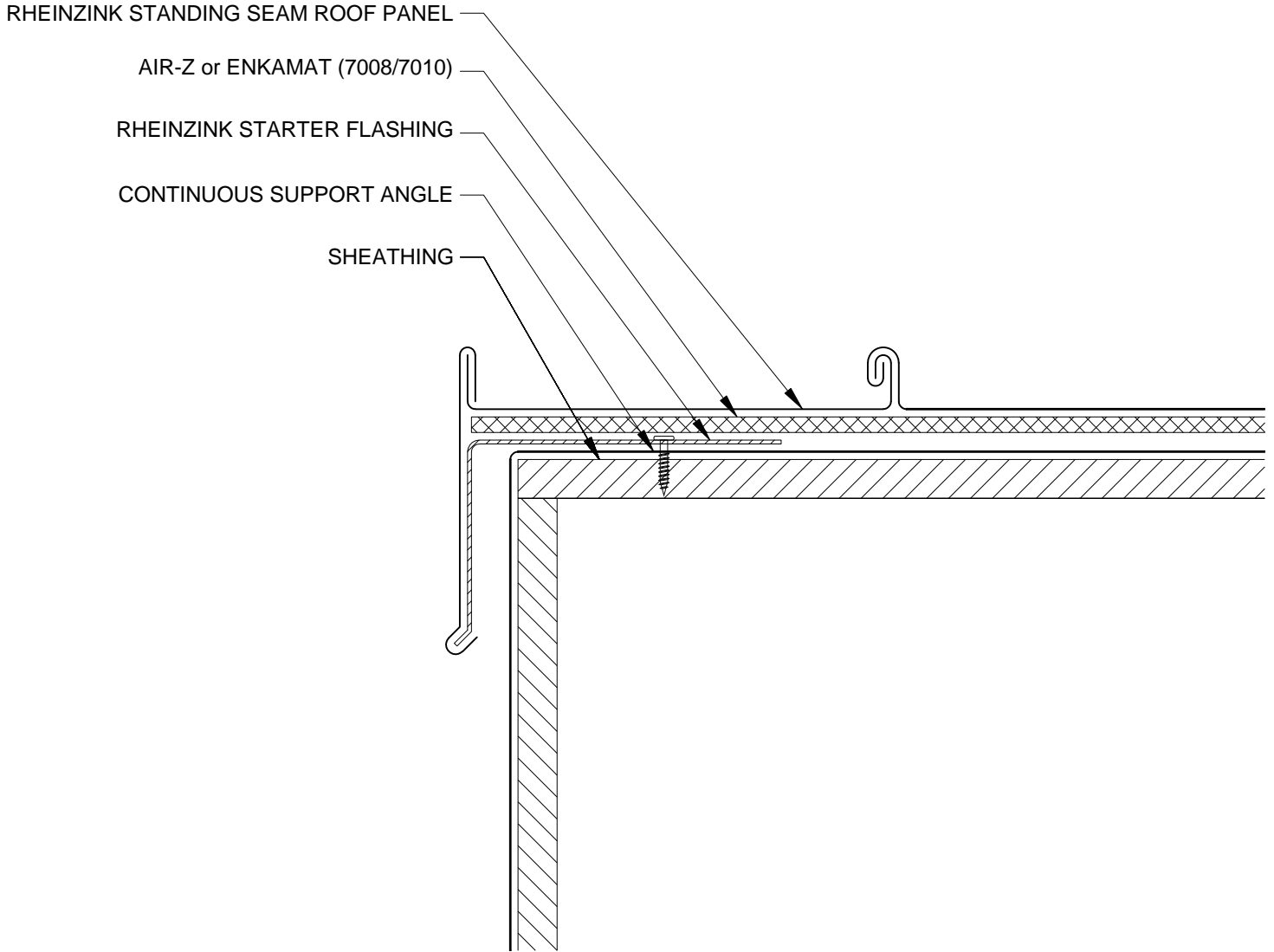

**NOTES:**

1. STANDING SEAM PANELS REQUIRE A MIN. OF 5/8:12 SLOPE.
2. STANDING SEAM PANEL SYSTEMS REQUIRE RHEINZINK PROROOING OR AIR-Z OR ENKAMAT (7008 OR 7010); SEE REQUIREMENTS BASED ON SLOPE.
3. RHEINZINK RECOMMENDS STAINLESS STEEL FASTENERS AND CLIPS.



96F Commerce Way Woburn, MA 01801 T: 781.729.0812  
 Website: www.rheinzink.com E-mail: info@rheinzink.com

INFORMATION AND DETAILS HEREIN ARE ONLY A BASELINE FOR SYSTEM DESIGN AND INSTALLATION. MODIFICATION TO MEET PROJECT REQUIREMENTS IS THE RESPONSIBILITY OF THE DESIGNER AND ARCHITECT. RHEINZINK AMERICA STAFF ARE AVAILABLE TO ASSIST THE DESIGNER AND ARCHITECT IN THIS PROCESS. RHEINZINK AMERICA MAKES NO REPRESENTATIONS AND WARRANTIES OTHER THAN THOSE EXPRESSED HEREIN.

PROJECT:	STANDING SEAM ROOF DETAILS	DATE:	08-2011
DRAWING TITLE:	RAKE EDGE DETAIL - OPT. 2	SCALE:	N.T.S.
COPYRIGHT RESERVED. THIS DRAWING REMAINS THE PROPERTY OF RHEINZINK.		SHEET:	SSR-8b

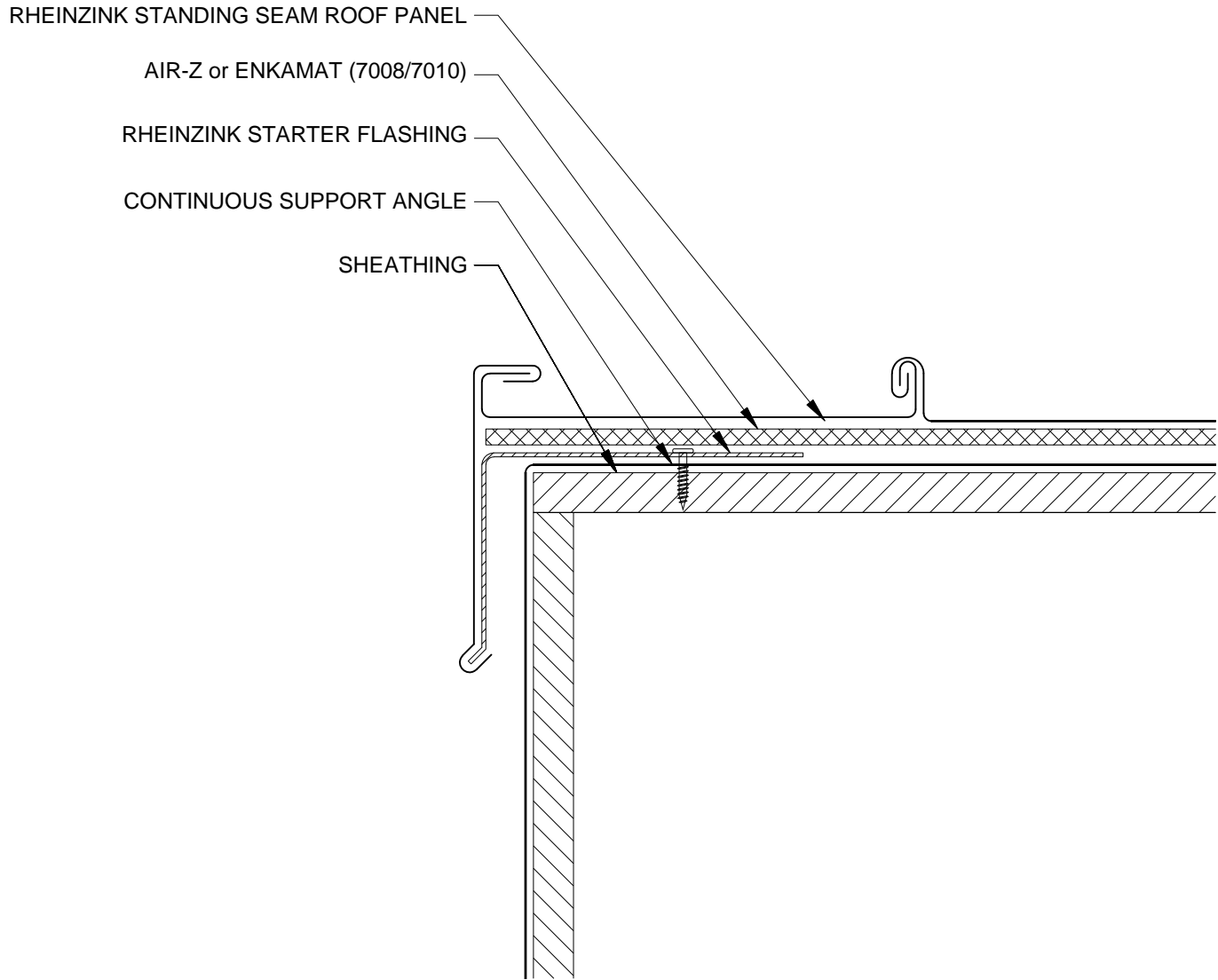

**NOTES:**

1. STANDING SEAM PANELS REQUIRE A MIN. OF 5/8:12 SLOPE.
2. STANDING SEAM PANEL SYSTEMS REQUIRE RHEINZINK PROROOING OR AIR-Z OR ENKAMAT (7008 OR 7010); SEE REQUIREMENTS BASED ON SLOPE.
- 3.) RHEINZINK RECOMMENDS STAINLESS STEEL FASTENERS AND CLIPS.

 <p style="font-size: small; margin-top: 5px;">96F Commerce Way Woburn, MA 01801 T: 781.729.0812 Website: www.rheinzink.com E-mail: info@rheinzink.com</p>	
<p style="font-size: x-small; margin: 0;">INFORMATION AND DETAILS HEREIN ARE ONLY A BASELINE FOR SYSTEM DESIGN AND INSTALLATION. MODIFICATION TO MEET PROJECT REQUIREMENTS IS THE RESPONSIBILITY OF THE DESIGNER AND ARCHITECT. RHEINZINK AMERICA STAFF ARE AVAILABLE TO ASSIST THE DESIGNER AND ARCHITECT IN THIS PROCESS. RHEINZINK AMERICA MAKES NO REPRESENTATIONS AND WARRANTIES OTHER THAN THOSE EXPRESSED HEREIN.</p>	
<p style="font-size: x-small; margin: 0;">PROJECT: <b>STANDING SEAM ROOF DETAILS</b></p>	<p style="font-size: x-small; margin: 0;">DATE: <b>10-2011</b></p>
<p style="font-size: x-small; margin: 0;">DRAWING TITLE: <b>RAKE EDGE DETAIL - OPT. 3</b></p>	<p style="font-size: x-small; margin: 0;">SCALE: <b>N.T.S.</b></p>
<p style="font-size: x-small; margin: 0;">COPYRIGHT RESERVED. THIS DRAWING REMAINS THE PROPERTY OF RHEINZINK.</p>	<p style="font-size: x-small; margin: 0;">SHEET: <b>SSR-8c</b></p>

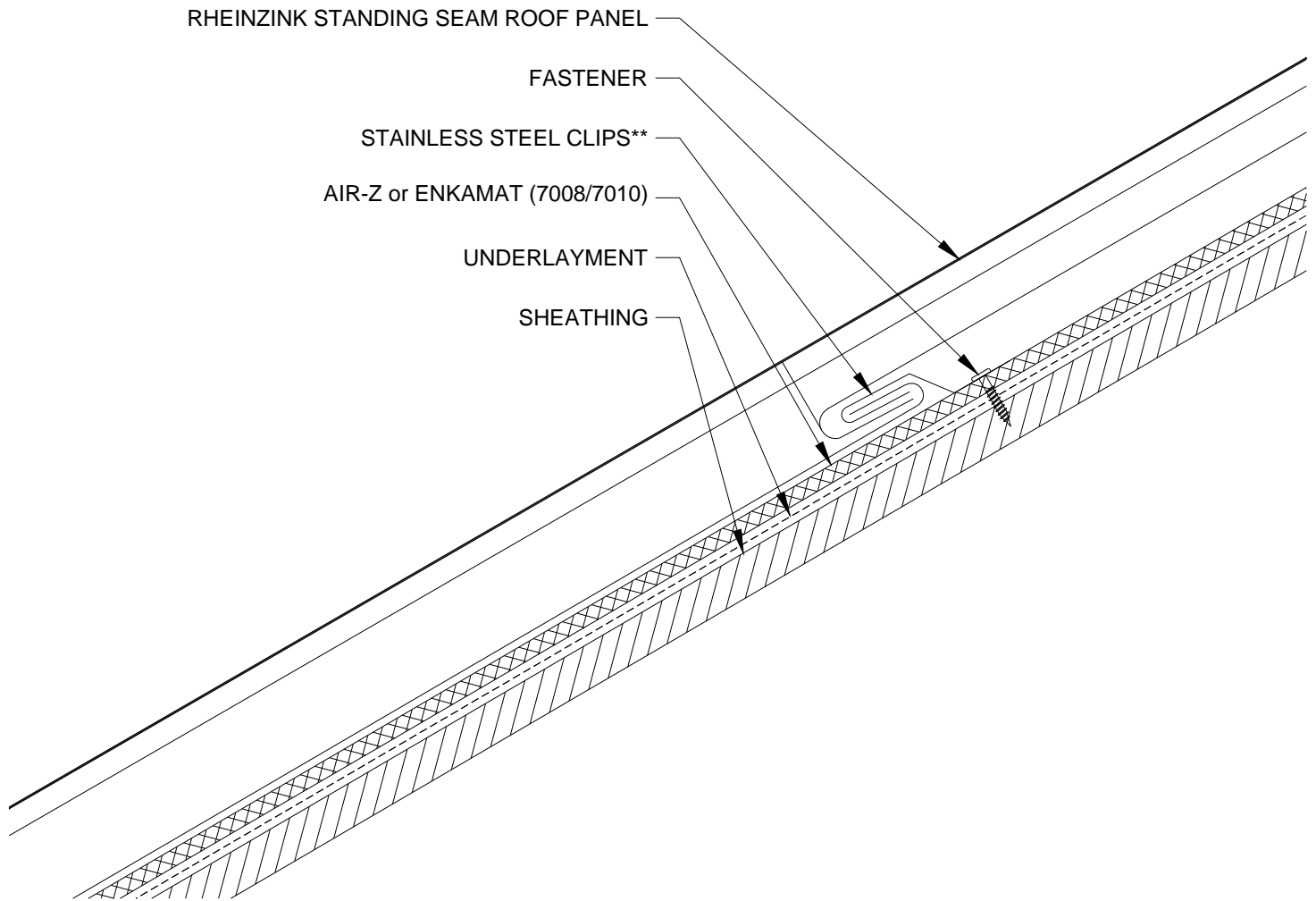

**NOTES:**

1. STANDING SEAM PANELS REQUIRE A MIN. OF 6:12 SLOPE.
2. STANDING SEAM PANEL SYSTEMS REQUIRE RHEINZINK PROROOING OR AIR-Z OR ENKAMAT (7008 OR 7010); SEE REQUIREMENTS BASED ON SLOPE.
3. RHEINZINK RECOMMENDS STAINLESS STEEL FASTENERS AND CLIPS.

	
96F Commerce Way Woburn, MA 01801 T: 781.729.0812 Website: www.rheinzink.com E-mail: info@rheinzink.com	
INFORMATION AND DETAILS HEREIN ARE ONLY A BASELINE FOR SYSTEM DESIGN AND INSTALLATION. MODIFICATION TO MEET PROJECT REQUIREMENTS IS THE RESPONSIBILITY OF THE DESIGNER AND ARCHITECT. RHEINZINK AMERICA STAFF ARE AVAILABLE TO ASSIST THE DESIGNER AND ARCHITECT IN THIS PROCESS. RHEINZINK AMERICA MAKES NO REPRESENTATIONS AND WARRANTIES OTHER THAN THOSE EXPRESSED HEREIN.	
PROJECT:	<b>STANDING SEAM ROOF DETAILS</b>
DATE:	03-2012
DRAWING TITLE:	<b>STEEP SLOPE CROSS JOINT DETAIL</b>
SCALE:	N.T.S.
COPYRIGHT RESERVED. THIS DRAWING REMAINS THE PROPERTY OF RHEINZINK.	SHEET: <b>SSR-9</b>

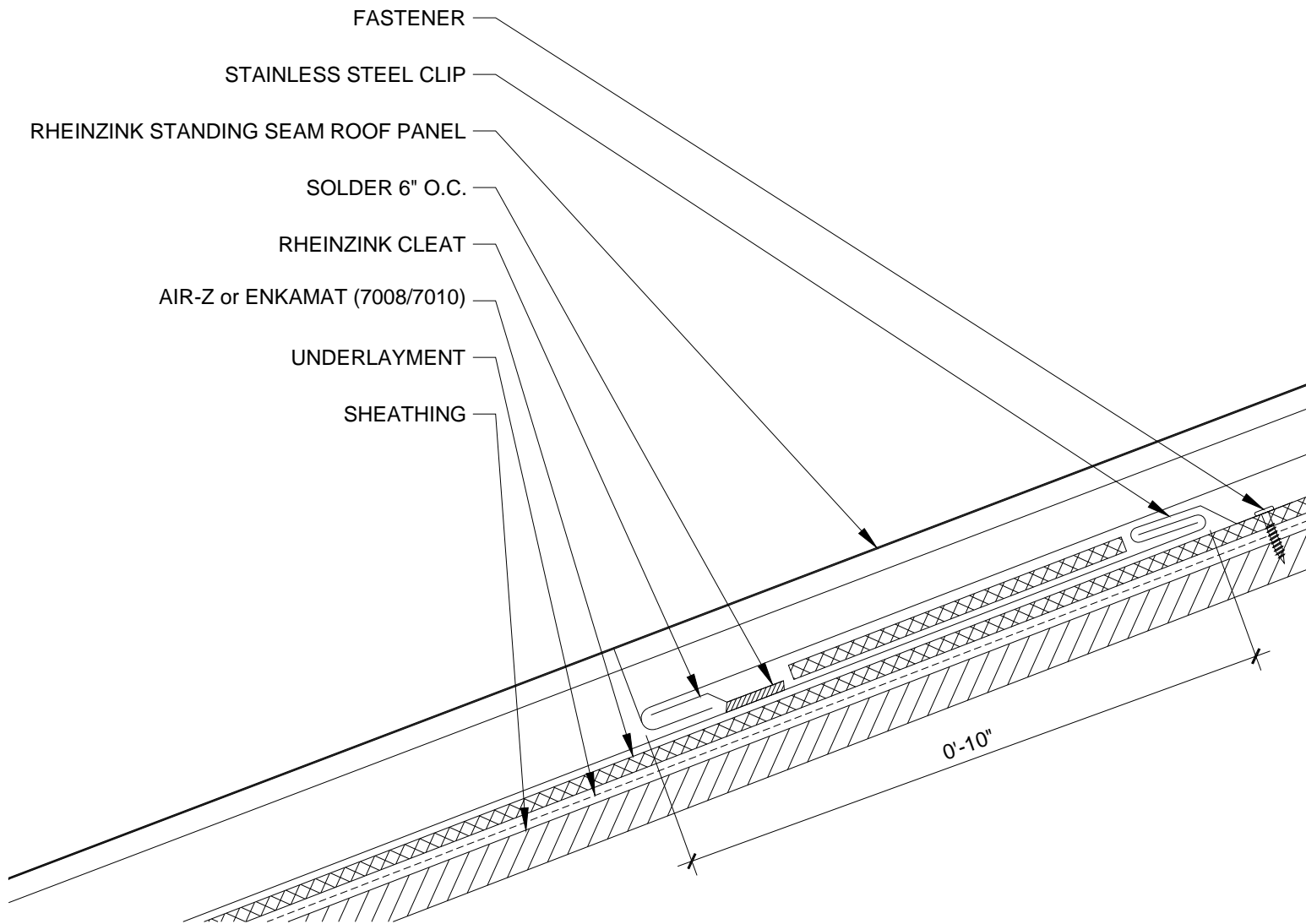

**NOTES:**

1. STANDING SEAM PANELS REQUIRE A MIN. OF 3:12 SLOPE.
2. STANDING SEAM PANEL SYSTEMS REQUIRE RHEINZINK PROROOING OR AIR-Z OR ENKAMAT (7008 OR 7010); SEE REQUIREMENTS BASED ON SLOPE.
3. RHEINZINK RECOMMENDS STAINLESS STEEL FASTENERS AND CLIPS.

	
96F Commerce Way Woburn, MA 01801 T: 781.729.0812 Website: www.rheinzink.com E-mail: info@rheinzink.com	
INFORMATION AND DETAILS HEREIN ARE ONLY A BASELINE FOR SYSTEM DESIGN AND INSTALLATION. MODIFICATION TO MEET PROJECT REQUIREMENTS IS THE RESPONSIBILITY OF THE DESIGNER AND ARCHITECT. RHEINZINK AMERICA STAFF ARE AVAILABLE TO ASSIST THE DESIGNER AND ARCHITECT IN THIS PROCESS. RHEINZINK AMERICA MAKES NO REPRESENTATIONS AND WARRANTIES OTHER THAN THOSE EXPRESSED HEREIN.	
PROJECT:	<b>STANDING SEAM ROOF DETAILS</b>
DATE:	<b>08-2011</b>
DRAWING TITLE:	<b>MID SLOPE CROSS JOINT DETAIL</b>
SCALE:	<b>N.T.S.</b>
COPYRIGHT RESERVED. THIS DRAWING REMAINS THE PROPERTY OF RHEINZINK.	SHEET: <b>SSR-10</b>

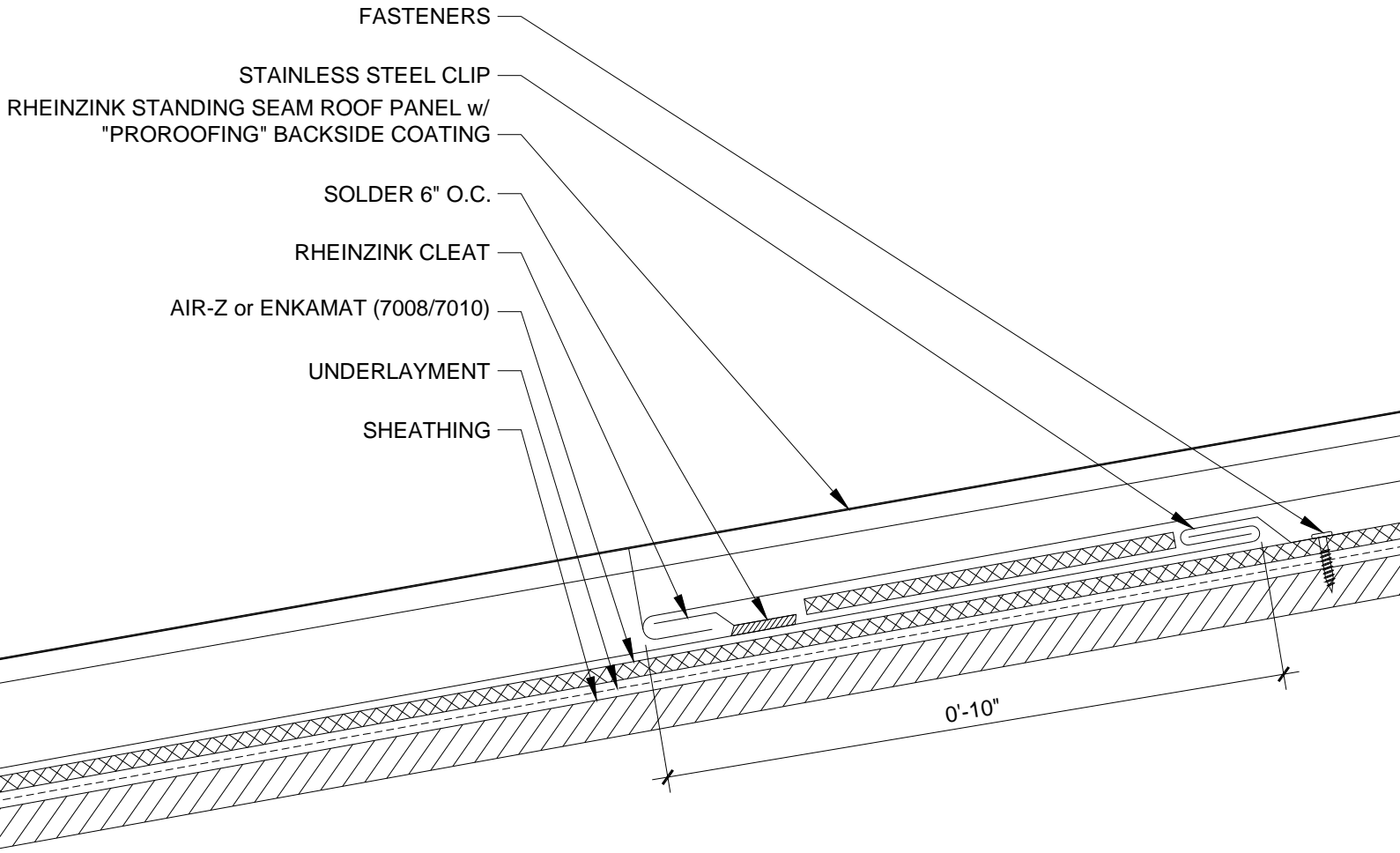

**NOTES:**

1. STANDING SEAM PANELS REQUIRE A MIN. OF 2:12 SLOPE.
2. STANDING SEAM PANEL SYSTEMS REQUIRE RHEINZINK PROROOING OR AIR-Z OR ENKAMAT (7008 OR 7010); SEE REQUIREMENTS BASED ON SLOPE.
3. RHEINZINK RECOMMENDS STAINLESS STEEL FASTENERS AND CLIPS.

	
96F Commerce Way Woburn, MA 01801 T: 781.729.0812 Website: www.rheinzink.com E-mail: info@rheinzink.com	
INFORMATION AND DETAILS HEREIN ARE ONLY A BASELINE FOR SYSTEM DESIGN AND INSTALLATION. MODIFICATION TO MEET PROJECT REQUIREMENTS IS THE RESPONSIBILITY OF THE DESIGNER AND ARCHITECT. RHEINZINK AMERICA STAFF ARE AVAILABLE TO ASSIST THE DESIGNER AND ARCHITECT IN THIS PROCESS. RHEINZINK AMERICA MAKES NO REPRESENTATIONS AND WARRANTIES OTHER THAN THOSE EXPRESSED HEREIN.	
PROJECT:	<b>STANDING SEAM ROOF DETAILS</b>
DATE:	08-2011
DRAWING TITLE:	<b>LOW SLOPE CROSS JOINT DETAIL</b>
SCALE:	N.T.S.
COPYRIGHT RESERVED. THIS DRAWING REMAINS THE PROPERTY OF RHEINZINK.	SHEET: <b>SSR-11</b>

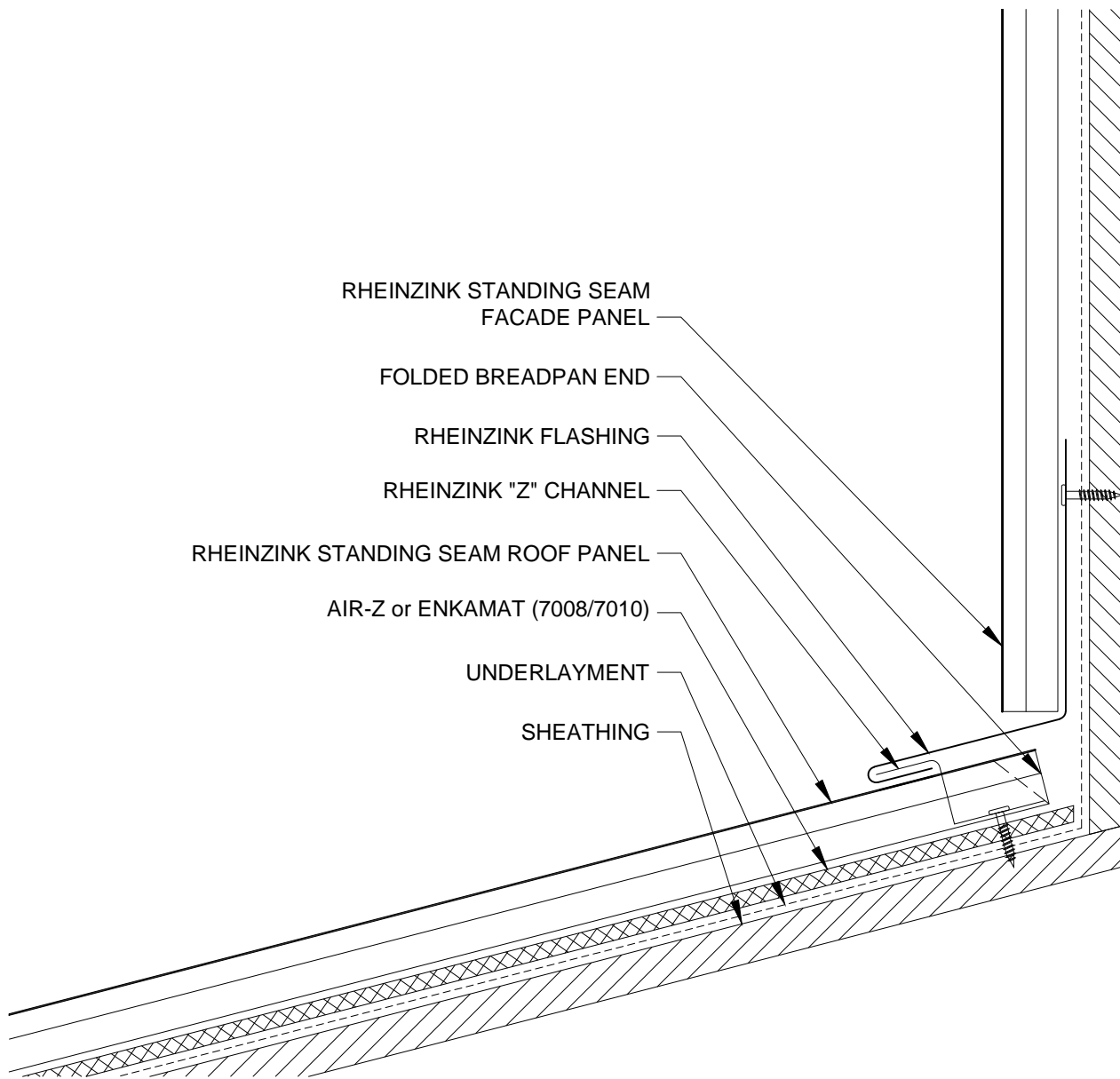

**NOTES:**

1. STANDING SEAM PANELS REQUIRE A MIN. OF 5/8:12 SLOPE.
2. STANDING SEAM PANEL SYSTEMS REQUIRE RHEINZINK PROROOING OR AIR-Z OR ENKAMAT (7008 OR 7010); SEE REQUIREMENTS BASED ON SLOPE.
3. RHEINZINK RECOMMENDS STAINLESS STEEL FASTENERS AND CLIPS.

	
96F Commerce Way Woburn, MA 01801 T: 781.729.0812 Website: www.rheinzink.com E-mail: info@rheinzink.com	
INFORMATION AND DETAILS HEREIN ARE ONLY A BASELINE FOR SYSTEM DESIGN AND INSTALLATION. MODIFICATION TO MEET PROJECT REQUIREMENTS IS THE RESPONSIBILITY OF THE DESIGNER AND ARCHITECT. RHEINZINK AMERICA STAFF ARE AVAILABLE TO ASSIST THE DESIGNER AND ARCHITECT IN THIS PROCESS. RHEINZINK AMERICA MAKES NO REPRESENTATIONS AND WARRANTIES OTHER THAN THOSE EXPRESSED HEREIN.	
PROJECT:	STANDING SEAM ROOF DETAILS
DATE:	08-2011
DRAWING TITLE:	ROOF TO WALL TRANS. - OPT. 1
SCALE:	N.T.S.
COPYRIGHT RESERVED. THIS DRAWING REMAINS THE PROPERTY OF RHEINZINK.	SHEET: SSR-12a

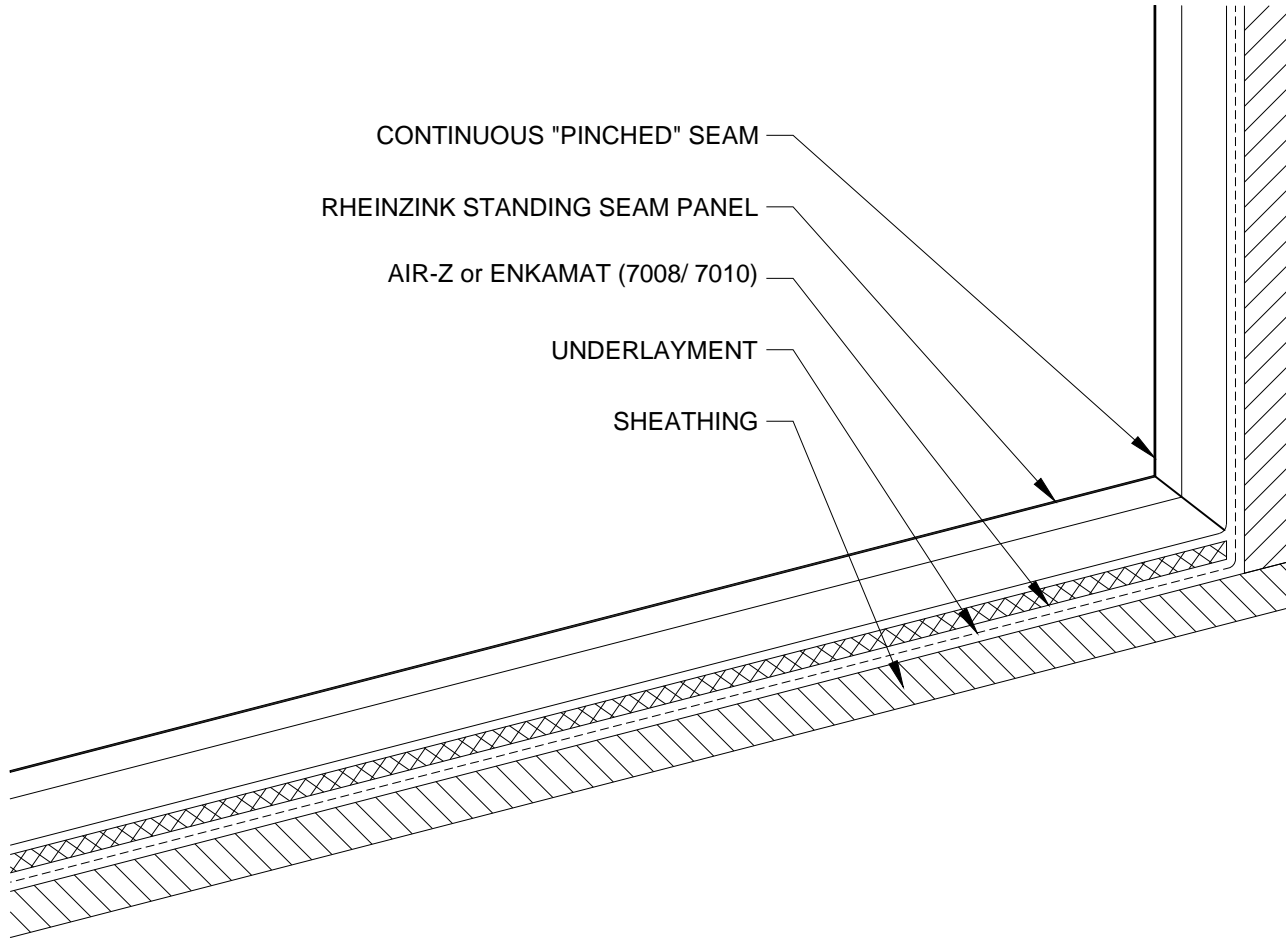

**NOTES:**

1. STANDING SEAM PANELS REQUIRE A MIN. OF 5/8:12 SLOPE.
2. STANDING SEAM PANEL SYSTEMS REQUIRE RHEINZINK PROROOING OR AIR-Z OR ENKAMAT (7008 OR 7010); SEE REQUIREMENTS BASED ON SLOPE.
3. RHEINZINK RECOMMENDS STAINLESS STEEL FASTENERS AND CLIPS.

	
96F Commerce Way Woburn, MA 01801 T: 781.729.0812 Website: www.rheinzink.com E-mail: info@rheinzink.com	
INFORMATION AND DETAILS HEREIN ARE ONLY A BASELINE FOR SYSTEM DESIGN AND INSTALLATION. MODIFICATION TO MEET PROJECT REQUIREMENTS IS THE RESPONSIBILITY OF THE DESIGNER AND ARCHITECT. RHEINZINK AMERICA STAFF ARE AVAILABLE TO ASSIST THE DESIGNER AND ARCHITECT IN THIS PROCESS. RHEINZINK AMERICA MAKES NO REPRESENTATIONS AND WARRANTIES OTHER THAN THOSE EXPRESSED HEREIN.	
PROJECT:	STANDING SEAM ROOF DETAILS
DRAWING TITLE:	ROOF TO WALL TRANS. - OPT. 2
DATE:	08-2011
SCALE:	N.T.S.
COPYRIGHT RESERVED. THIS DRAWING REMAINS THE PROPERTY OF RHEINZINK.	SHEET: SSR-12b



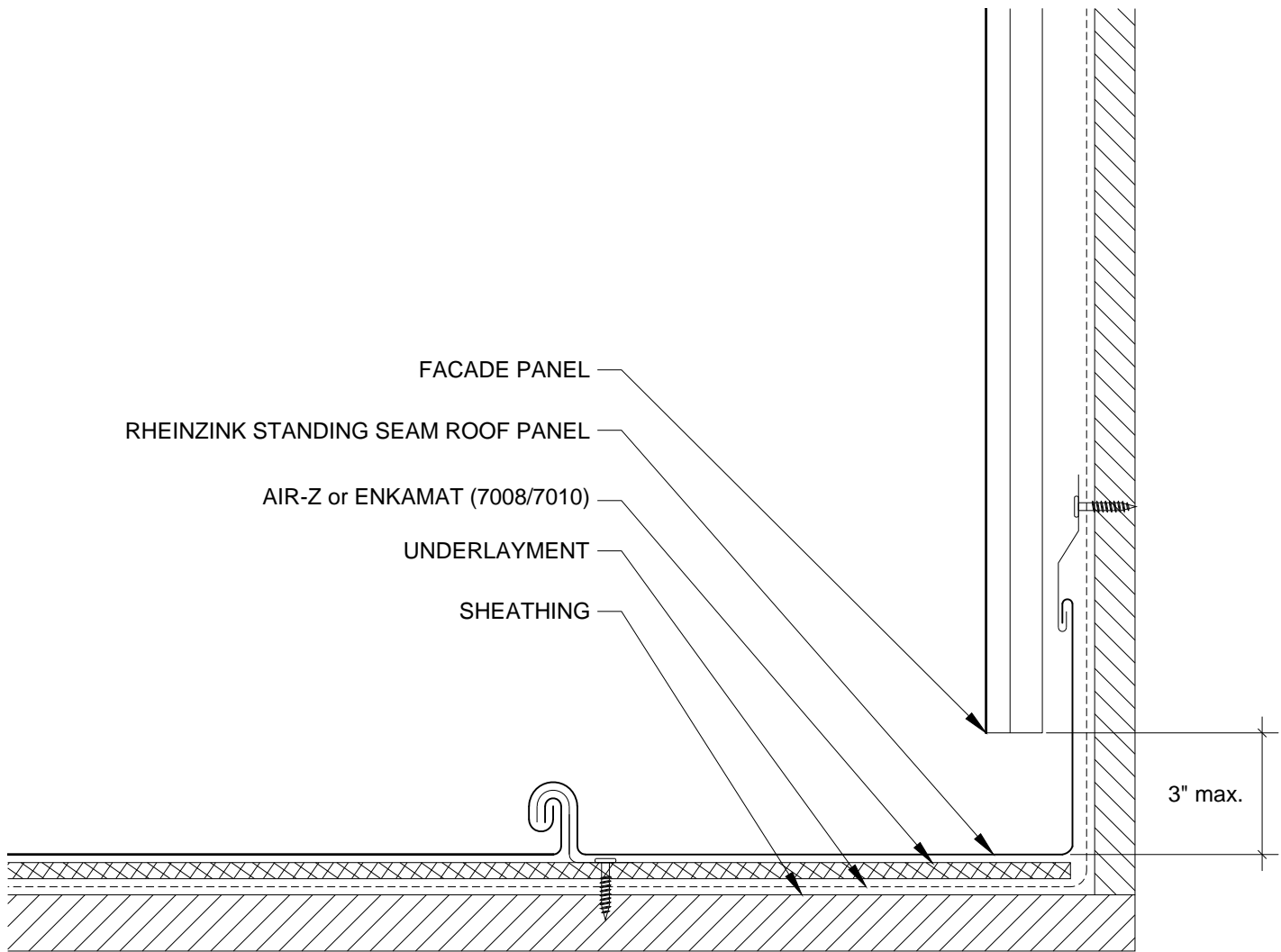

**NOTES:**

1. STANDING SEAM PANELS REQUIRE A MIN. OF 5/8:12 SLOPE.
2. STANDING SEAM PANEL SYSTEMS REQUIRE RHEINZINK PROROOING OR AIR-Z OR ENKAMAT (7008 OR 7010); SEE REQUIREMENTS BASED ON SLOPE.
3. RHEINZINK RECOMMENDS STAINLESS STEEL FASTENERS AND CLIPS.



96F Commerce Way Woburn, MA 01801 T: 781.729.0812  
 Website: www.rheinzink.com E-mail: info@rheinzink.com

INFORMATION AND DETAILS HEREIN ARE ONLY A BASELINE FOR SYSTEM DESIGN AND INSTALLATION. MODIFICATION TO MEET PROJECT REQUIREMENTS IS THE RESPONSIBILITY OF THE DESIGNER AND ARCHITECT. RHEINZINK AMERICA STAFF ARE AVAILABLE TO ASSIST THE DESIGNER AND ARCHITECT IN THIS PROCESS. RHEINZINK AMERICA MAKES NO REPRESENTATIONS AND WARRANTIES OTHER THAN THOSE EXPRESSED HEREIN.

PROJECT:	STANDING SEAM ROOF DETAILS	DATE:	10-2011
DRAWING TITLE:	SIDEWALL DETAIL - OPT. 1	SCALE:	N.T.S.
COPYRIGHT RESERVED. THIS DRAWING REMAINS THE PROPERTY OF RHEINZINK.		SHEET:	SSR-13a

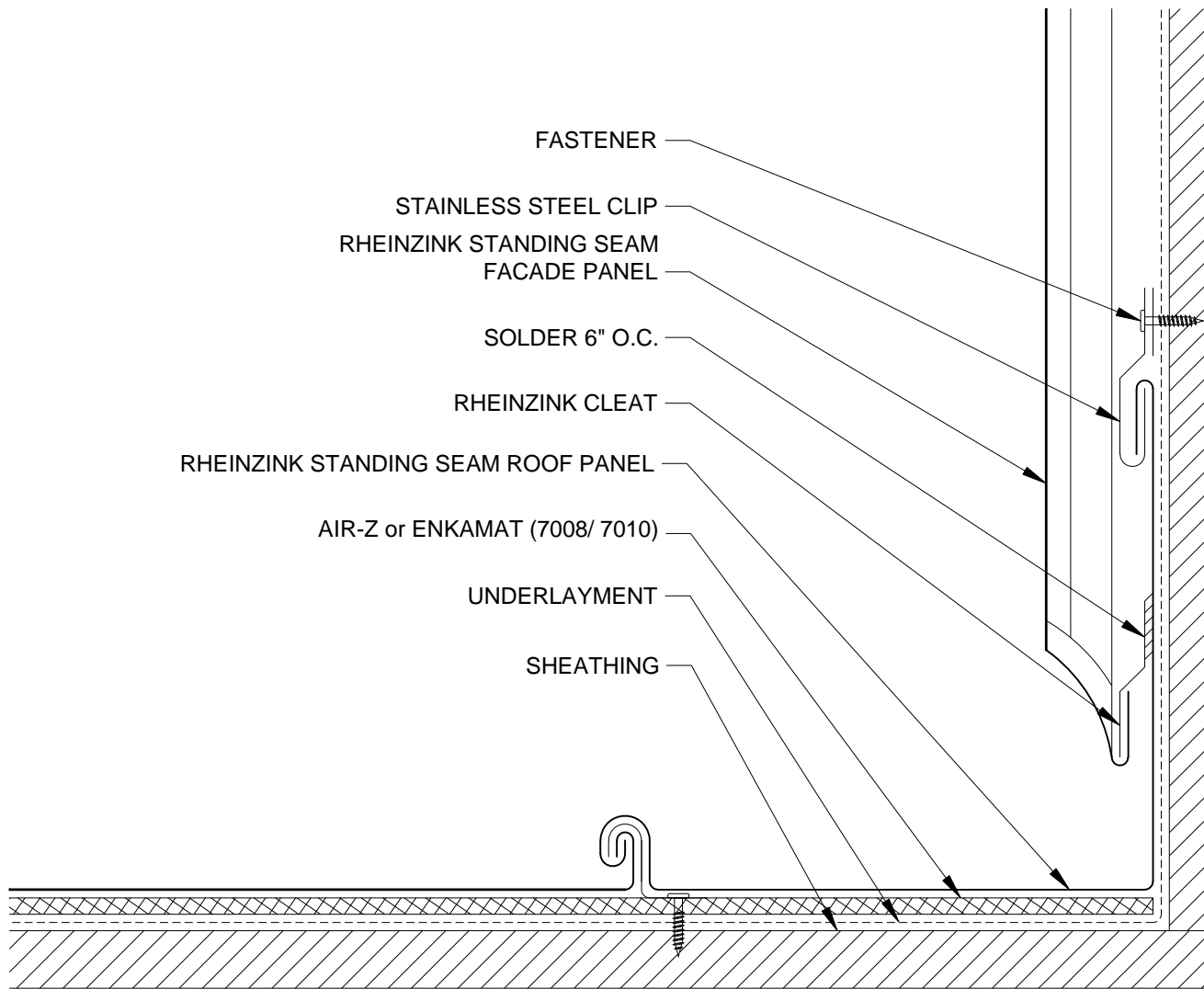

**NOTES:**

1. STANDING SEAM PANELS REQUIRE A MIN. OF 5/8:12 SLOPE.
2. STANDING SEAM PANEL SYSTEMS REQUIRE RHEINZINK PROROOING OR AIR-Z OR ENKAMAT (7008 OR 7010); SEE REQUIREMENTS BASED ON SLOPE.
3. RHEINZINK RECOMMENDS STAINLESS STEEL FASTENERS AND CLIPS.

	
96F Commerce Way Woburn, MA 01801 T: 781.729.0812 Website: www.rheinzink.com E-mail: info@rheinzink.com	
INFORMATION AND DETAILS HEREIN ARE ONLY A BASELINE FOR SYSTEM DESIGN AND INSTALLATION. MODIFICATION TO MEET PROJECT REQUIREMENTS IS THE RESPONSIBILITY OF THE DESIGNER AND ARCHITECT. RHEINZINK AMERICA STAFF ARE AVAILABLE TO ASSIST THE DESIGNER AND ARCHITECT IN THIS PROCESS. RHEINZINK AMERICA MAKES NO REPRESENTATIONS AND WARRANTIES OTHER THAN THOSE EXPRESSED HEREIN.	
PROJECT:	STANDING SEAM ROOF DETAILS
DATE:	08-2011
DRAWING TITLE:	SIDEWALL DETAIL - OPT. 2
SCALE:	N.T.S.
COPYRIGHT RESERVED. THIS DRAWING REMAINS THE PROPERTY OF RHEINZINK.	SHEET: SSR-13b

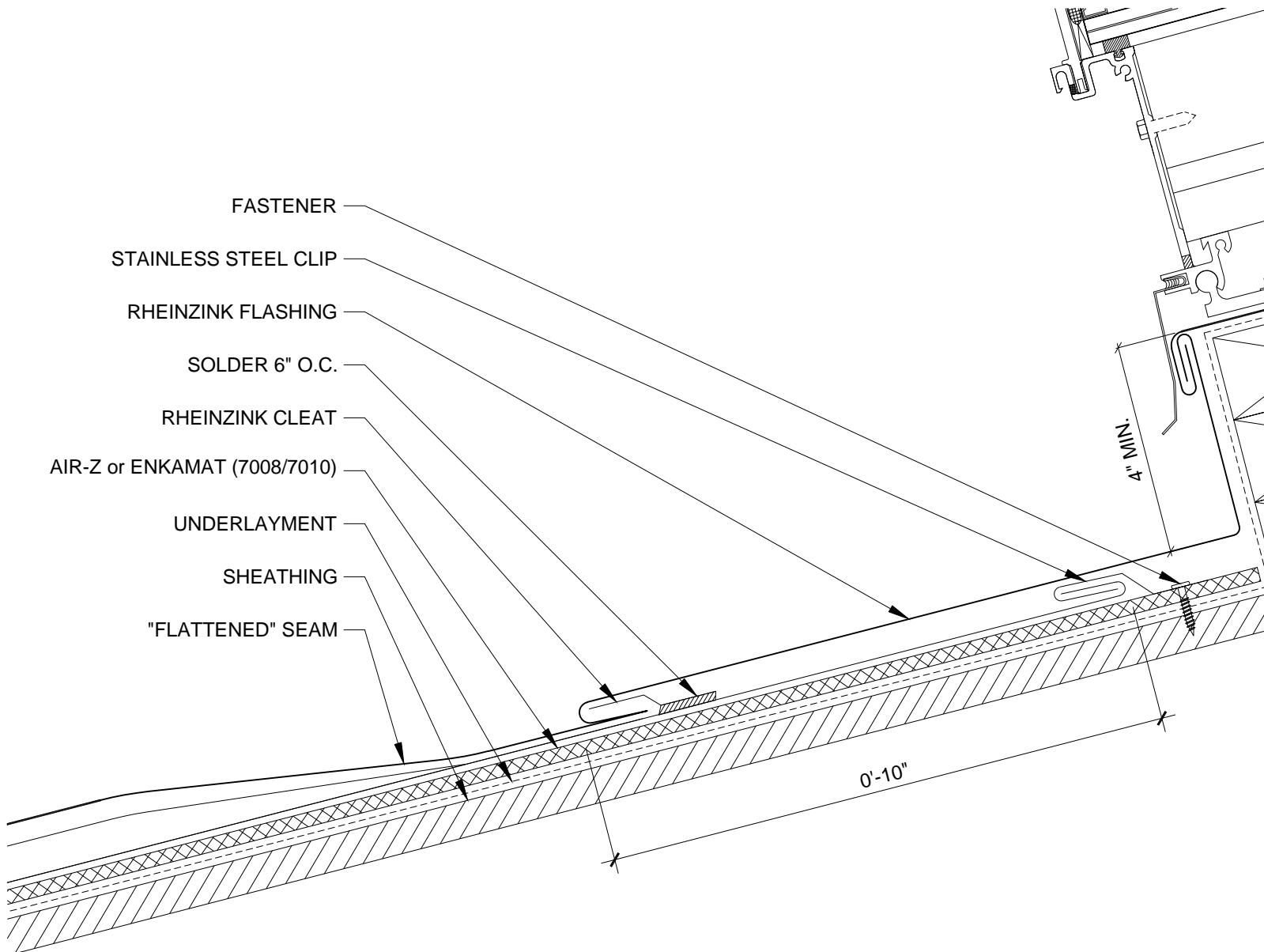

**NOTES:**

1. STANDING SEAM PANELS REQUIRE A MIN. OF 5/8:12 SLOPE.
2. STANDING SEAM PANEL SYSTEMS REQUIRE RHEINZINK PROROOING OR AIR-Z OR ENKAMAT (7008 OR 7010); SEE REQUIREMENTS BASED ON SLOPE.
3. RHEINZINK RECOMMENDS STAINLESS STEEL FASTENERS AND CLIPS.

	
96F Commerce Way Woburn, MA 01801 T: 781.729.0812 Website: www.rheinzink.com E-mail: info@rheinzink.com	
INFORMATION AND DETAILS HEREIN ARE ONLY A BASELINE FOR SYSTEM DESIGN AND INSTALLATION. MODIFICATION TO MEET PROJECT REQUIREMENTS IS THE RESPONSIBILITY OF THE DESIGNER AND ARCHITECT. RHEINZINK AMERICA STAFF ARE AVAILABLE TO ASSIST THE DESIGNER AND ARCHITECT IN THIS PROCESS. RHEINZINK AMERICA MAKES NO REPRESENTATIONS AND WARRANTIES OTHER THAN THOSE EXPRESSED HEREIN.	
PROJECT:	STANDING SEAM ROOF DETAILS
DATE:	08-2011
DRAWING TITLE:	SKYLIGHT SILL DETAIL
SCALE:	N.T.S.
COPYRIGHT RESERVED. THIS DRAWING REMAINS THE PROPERTY OF RHEINZINK.	SHEET: SSR-14

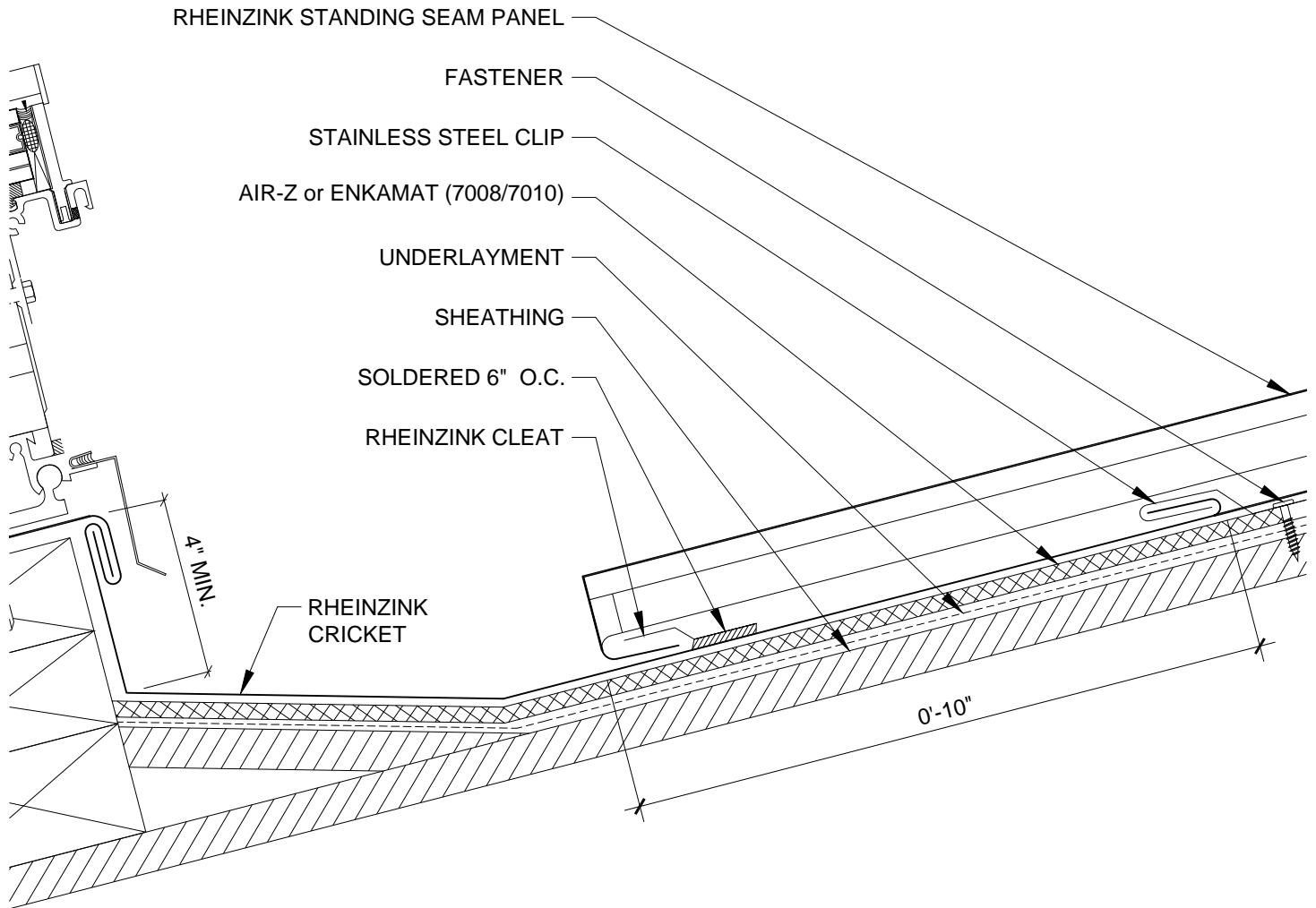

**NOTES:**

1. STANDING SEAM PANELS REQUIRE A MIN. OF 5/8:12 SLOPE.
2. STANDING SEAM PANEL SYSTEMS REQUIRE RHEINZINK PROROOING OR AIR-Z OR ENKAMAT (7008 OR 7010); SEE REQUIREMENTS BASED ON SLOPE.
3. RHEINZINK RECOMMENDS STAINLESS STEEL FASTENERS AND CLIPS.

	
96F Commerce Way Woburn, MA 01801 T: 781.729.0812 Website: www.rheinzink.com E-mail: info@rheinzink.com	
INFORMATION AND DETAILS HEREIN ARE ONLY A BASELINE FOR SYSTEM DESIGN AND INSTALLATION. MODIFICATION TO MEET PROJECT REQUIREMENTS IS THE RESPONSIBILITY OF THE DESIGNER AND ARCHITECT. RHEINZINK AMERICA STAFF ARE AVAILABLE TO ASSIST THE DESIGNER AND ARCHITECT IN THIS PROCESS. RHEINZINK AMERICA MAKES NO REPRESENTATIONS AND WARRANTIES OTHER THAN THOSE EXPRESSED HEREIN.	
PROJECT:	STANDING SEAM ROOF DETAILS
DATE:	08-2011
DRAWING TITLE:	SKYLIGHT HEAD DETAIL - OPT. 1
SCALE:	N.T.S.
COPYRIGHT RESERVED. THIS DRAWING REMAINS THE PROPERTY OF RHEINZINK.	SHEET: SSR-15a

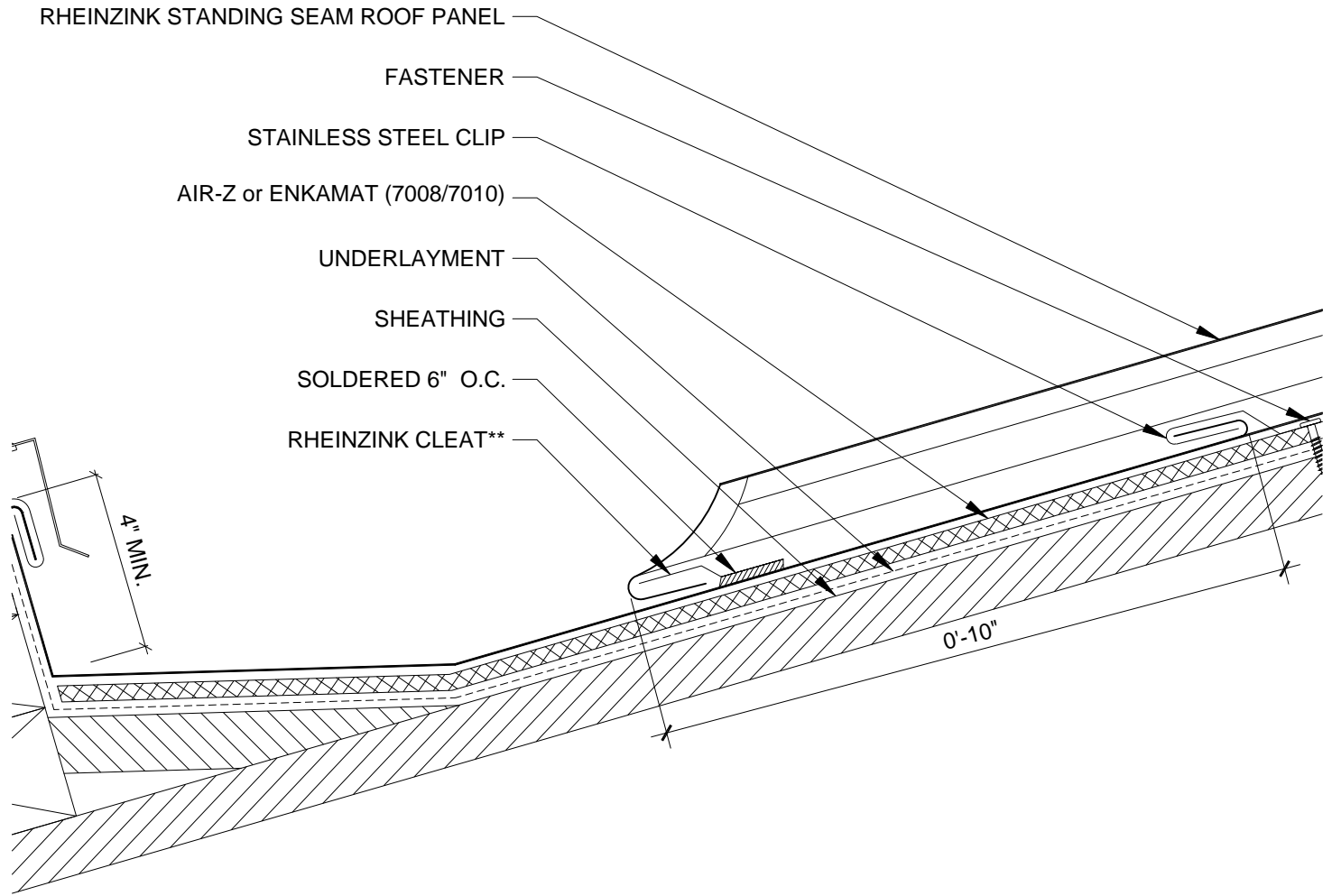

**NOTES:**

1. STANDING SEAM PANELS REQUIRE A MIN. OF 5/8:12 SLOPE.
2. STANDING SEAM PANEL SYSTEMS REQUIRE RHEINZINK PROROOING OR AIR-Z OR ENKAMAT (7008 OR 7010); SEE REQUIREMENTS BASED ON SLOPE.
3. RHEINZINK RECOMMENDS STAINLESS STEEL FASTENERS AND CLIPS.

	
96F Commerce Way Woburn, MA 01801 T: 781.729.0812 Website: www.rheinzink.com E-mail: info@rheinzink.com	
INFORMATION AND DETAILS HEREIN ARE ONLY A BASELINE FOR SYSTEM DESIGN AND INSTALLATION. MODIFICATION TO MEET PROJECT REQUIREMENTS IS THE RESPONSIBILITY OF THE DESIGNER AND ARCHITECT. RHEINZINK AMERICA STAFF ARE AVAILABLE TO ASSIST THE DESIGNER AND ARCHITECT IN THIS PROCESS. RHEINZINK AMERICA MAKES NO REPRESENTATIONS AND WARRANTIES OTHER THAN THOSE EXPRESSED HEREIN.	
PROJECT:	STANDING SEAM ROOF DETAILS
DATE:	08-2011
DRAWING TITLE:	SKYLIGHT HEAD DETAIL - OPT. 2
SCALE:	N.T.S.
COPYRIGHT RESERVED. THIS DRAWING REMAINS THE PROPERTY OF RHEINZINK.	SHEET: SSR-15b

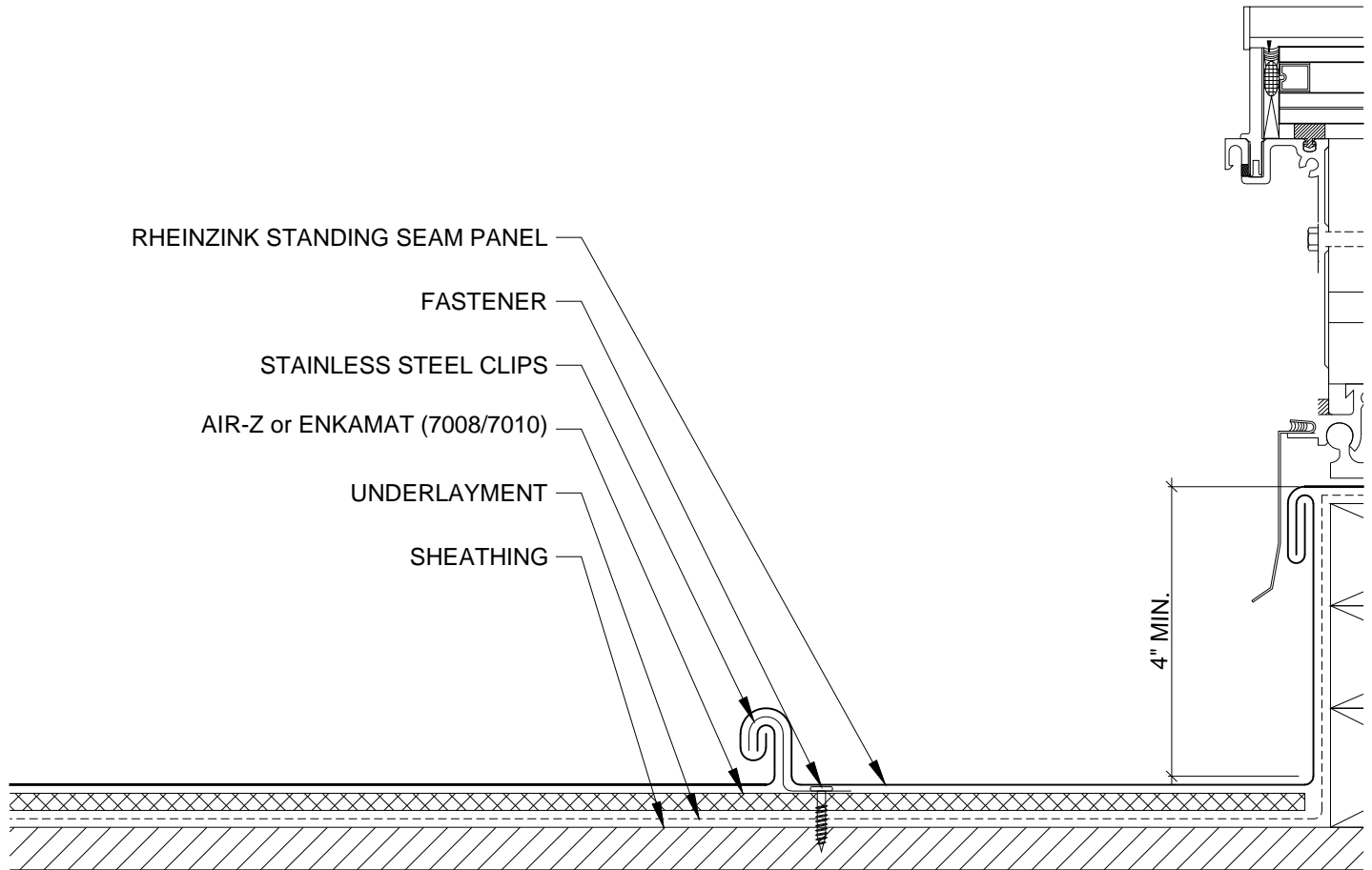

**NOTES:**

1. STANDING SEAM PANELS REQUIRE A MIN. OF 5/8:12 SLOPE.
2. STANDING SEAM PANEL SYSTEMS REQUIRE RHEINZINK PROROOING OR AIR-Z OR ENKAMAT (7008 OR 7010); SEE REQUIREMENTS BASED ON SLOPE.
3. RHEINZINK RECOMMENDS STAINLESS STEEL FASTENERS AND CLIPS.

	
96F Commerce Way Woburn, MA 01801 T: 781.729.0812 Website: www.rheinzink.com E-mail: info@rheinzink.com	
INFORMATION AND DETAILS HEREIN ARE ONLY A BASELINE FOR SYSTEM DESIGN AND INSTALLATION. MODIFICATION TO MEET PROJECT REQUIREMENTS IS THE RESPONSIBILITY OF THE DESIGNER AND ARCHITECT. RHEINZINK AMERICA STAFF ARE AVAILABLE TO ASSIST THE DESIGNER AND ARCHITECT IN THIS PROCESS. RHEINZINK AMERICA MAKES NO REPRESENTATIONS AND WARRANTIES OTHER THAN THOSE EXPRESSED HEREIN.	
PROJECT:	STANDING SEAM ROOF DETAILS
DATE:	08-2011
DRAWING TITLE:	SKYLIGHT JAMB DETAIL
SCALE:	N.T.S.
COPYRIGHT RESERVED. THIS DRAWING REMAINS THE PROPERTY OF RHEINZINK.	SHEET: SSR-16

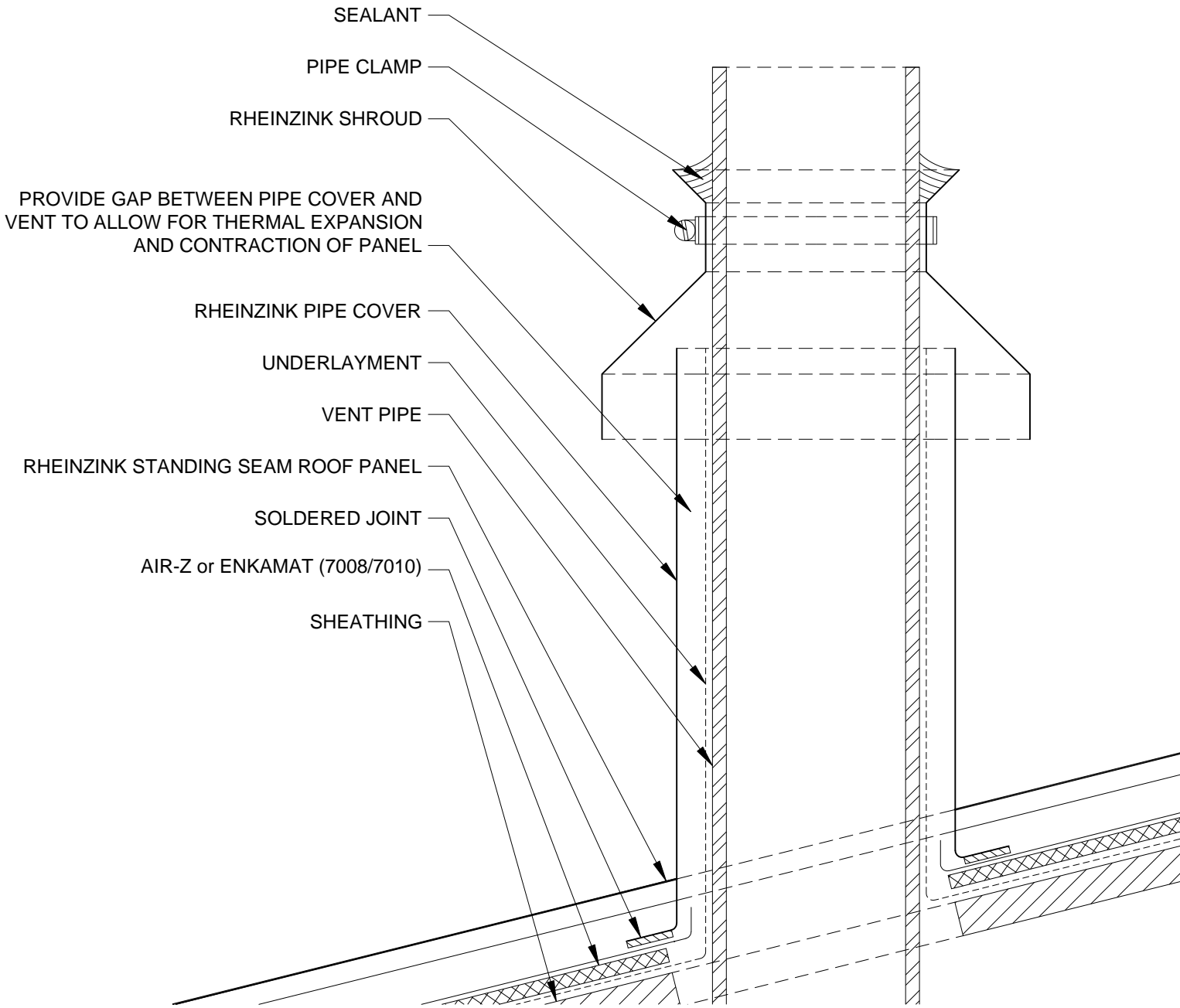

**NOTES:**

1. STANDING SEAM PANELS REQUIRE A MIN. OF 5/8:12 SLOPE.
2. STANDING SEAM PANEL SYSTEMS REQUIRE RHEINZINK PROROOING OR AIR-Z OR ENKAMAT (7008 OR 7010); SEE REQUIREMENTS BASED ON SLOPE.
3. RHEINZINK RECOMMENDS STAINLESS STEEL FASTENERS AND CLIPS.

	
96F Commerce Way Woburn, MA 01801 T: 781.729.0812 Website: www.rheinzink.com E-mail: info@rheinzink.com	
INFORMATION AND DETAILS HEREIN ARE ONLY A BASELINE FOR SYSTEM DESIGN AND INSTALLATION. MODIFICATION TO MEET PROJECT REQUIREMENTS IS THE RESPONSIBILITY OF THE DESIGNER AND ARCHITECT. RHEINZINK AMERICA STAFF ARE AVAILABLE TO ASSIST THE DESIGNER AND ARCHITECT IN THIS PROCESS. RHEINZINK AMERICA MAKES NO REPRESENTATIONS AND WARRANTIES OTHER THAN THOSE EXPRESSED HEREIN.	
PROJECT:	STANDING SEAM ROOF DETAILS
DATE:	01-2012
DRAWING TITLE:	VENT PIPE PENETRATION - OP. 1
SCALE:	N.T.S.
COPYRIGHT RESERVED. THIS DRAWING REMAINS THE PROPERTY OF RHEINZINK.	SHEET: SSR-17a

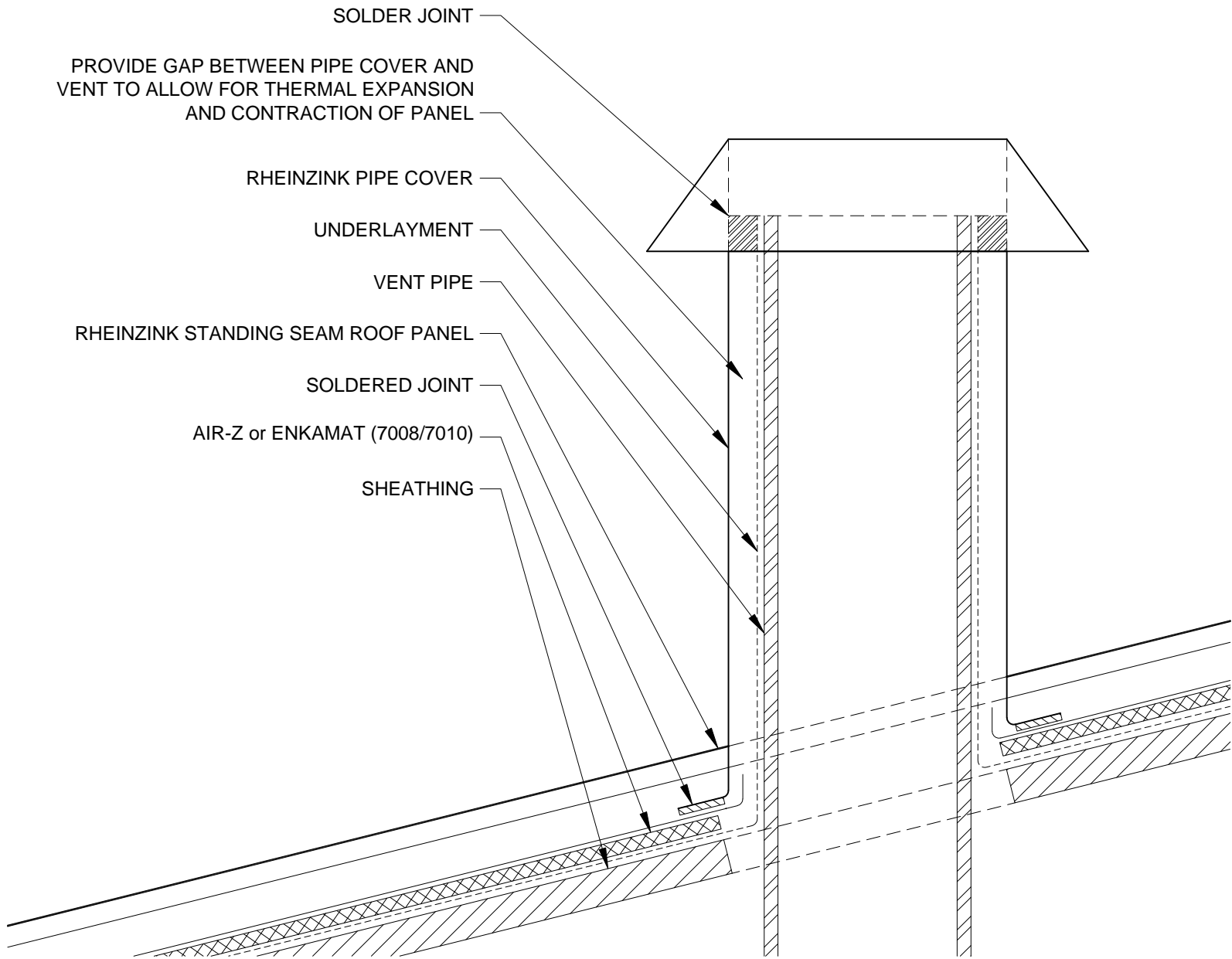

**NOTES:**

1. STANDING SEAM PANELS REQUIRE A MIN. OF 5/8:12 SLOPE.
2. STANDING SEAM PANEL SYSTEMS REQUIRE RHEINZINK PROROOING OR AIR-Z OR ENKAMAT (7008 OR 7010); SEE REQUIREMENTS BASED ON SLOPE.
3. RHEINZINK RECOMMENDS STAINLESS STEEL FASTENERS AND CLIPS.
4. PENETRATION MUST BE PANNED IF PIPE FALLS AT JOINT / RIB

	
96F Commerce Way Woburn, MA 01801 T: 781.729.0812 Website: www.rheinzink.com E-mail: info@rheinzink.com	
INFORMATION AND DETAILS HEREIN ARE ONLY A BASELINE FOR SYSTEM DESIGN AND INSTALLATION. MODIFICATION TO MEET PROJECT REQUIREMENTS IS THE RESPONSIBILITY OF THE DESIGNER AND ARCHITECT. RHEINZINK AMERICA STAFF ARE AVAILABLE TO ASSIST THE DESIGNER AND ARCHITECT IN THIS PROCESS. RHEINZINK AMERICA MAKES NO REPRESENTATIONS AND WARRANTIES OTHER THAN THOSE EXPRESSED HEREIN.	
PROJECT:	STANDING SEAM ROOF DETAILS
DATE:	01-2012
DRAWING TITLE:	VENT PIPE PENETRATION - OP. 2
SCALE:	N.T.S.
COPYRIGHT RESERVED. THIS DRAWING REMAINS THE PROPERTY OF RHEINZINK.	SHEET: SSR-17b



**GENERAL NOTES:**

1. ALL DIMENSIONS ARE INCHES OR FRACTIONS THEREOF.
2. MATERIAL .7mm OR .8mm RHEINZINK PREWEATHERED TITANIUM ZINC.

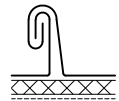
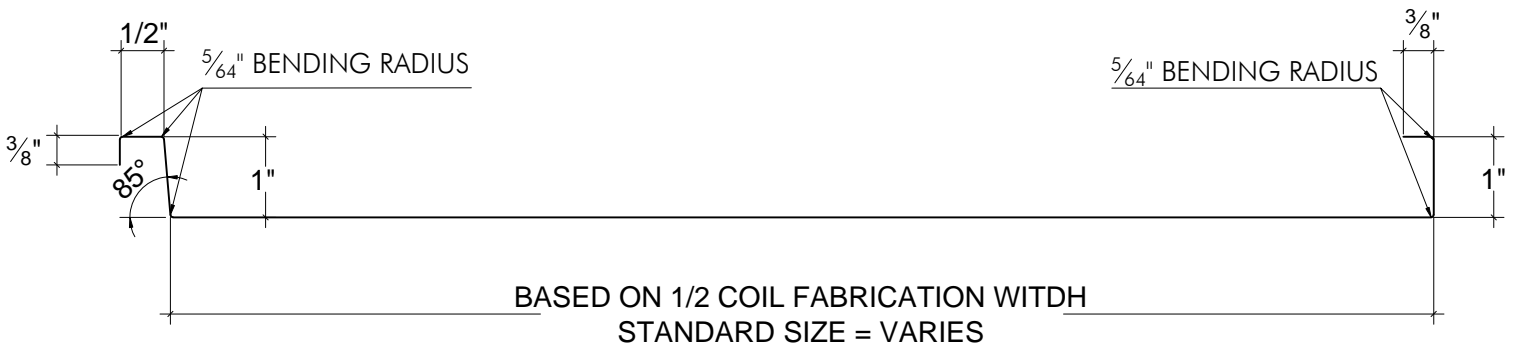

DOUBLE LOCK  
STANDING  
SEAM  
SLOPE > 3°  
(5/8:12)

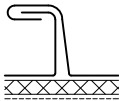

ANGLED  
STANDING SEAM  
SLOPE > 25° (6:12)  
SLOPE > 35° (9:12) IN  
AREAS OF HIGH  
SNOW

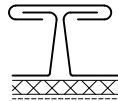

DOUBLE  
ANGLED  
STANDING  
SEAM  
SLOPE > 25°  
(6:12)

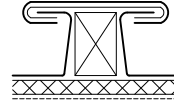

ROLL CAP - 2"  
SEAM HEIGHT  
SLOPE > 5°  
(1:12)

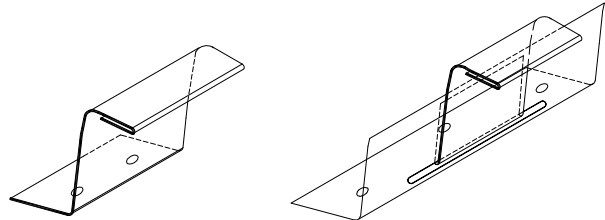

**NOTES:**

1. STANDING SEAM PANELS REQUIRE A MIN. OF 5/8:12 SLOPE.
2. STANDING SEAM PANEL SYSTEMS REQUIRE RHEINZINK PROROOING OR AIR-Z OR ENKAMAT (7008 OR 7010); SEE REQUIREMENTS BASED ON SLOPE.
3. RHEINZINK RECOMMENDS STAINLESS STEEL FASTENERS AND CLIPS.



96F Commerce Way Woburn, MA 01801 T: 781.729.0812  
Website: www.rheinzink.com E-mail: info@rheinzink.com

INFORMATION AND DETAILS HEREIN ARE ONLY A BASELINE FOR SYSTEM DESIGN AND INSTALLATION. MODIFICATION TO MEET PROJECT REQUIREMENTS IS THE RESPONSIBILITY OF THE DESIGNER AND ARCHITECT. RHEINZINK AMERICA STAFF ARE AVAILABLE TO ASSIST THE DESIGNER AND ARCHITECT IN THIS PROCESS. RHEINZINK AMERICA MAKES NO REPRESENTATIONS AND WARRANTIES OTHER THAN THOSE EXPRESSED HEREIN.

PROJECT:	STANDING SEAM ROOF DETAILS	DATE:	08-2011
DRAWING TITLE:	PANEL PROFILE & CLIP DETAIL	SCALE:	N.T.S.
COPYRIGHT RESERVED. THIS DRAWING REMAINS THE PROPERTY OF RHEINZINK.		SHEET:	SSR-18

## **SECTION 07 61 13 – STANDING SEAM ZINC ROOFING**

### **PART 1 - GENERAL**

#### **1.01 RELATED DOCUMENTS**

- A. All of the Contract Documents, including General and Supplementary Conditions and Division 1 Specification Sections, apply to the work of this Section.
- B. Examine all Drawings and all other Sections of the Specifications for requirements therein affecting the work of this Section.
- C. Coordinate work with that of all other trades affecting or affected by work of this Section. Cooperate with such trades to assure the steady progress of all work under the Contract.

#### **1.02 DESCRIPTION OF WORK**

- A. The Work of this Section shall include, but not be limited to, the following:
  - 1. Custom fabricated, mechanically attached, [RHEINZINK-CLASSIC bright rolled, RHEINZINK-prePATINA blue-grey, RHEINZINK-prePATINA graphite-grey, RHEINZINK-GRANUM skygrey, RHEINZINK-GRANUM basalte, RHEINZINK-artCOLOR various colors and PRISMO various colors] zinc alloy [reveal and shiplap panels] [vertical or horizontal] as indicated on the Drawings, with all required accessories for a weatherproof installation.
  - 2. [Zinc gutters and downspouts] as indicated on the Drawings.
  - 3. Zinc coping and wall trim as indicated on the Drawings
  - 4. Penetrations [doors, windows, louvers, etc...] in the wall assembly as indicated on the Drawings.
- B. Related Sections:
  - 1. Section 05400 – Cold Formed Metal Framing
  - 2. Section 06100 – Rough Carpentry
  - 3. Section 07210 – Building Insulation
  - 4. Section 07265 – Air and Vapor Barrier Membrane
  - 5. Section 07410 – Metal Wall Panel Systems
  - 6. Section 07500 – Membrane Roofing
  - 7. Section 07620 – Sheet Metal Flashing and Trim
  - 8. Section 07720 – Roof Accessories
  - 9. Section 07920 – Joint Sealants

#### **1.03 REFERENCES**

- 1. ASTM B69-16 (or latest edition) – Architectural Rolled Zinc - Types 1 and 2 – Standard Specification for rolled zinc.
- 2. RHEINZINK Division 7 Binder: latest edition.
- 3. RHEINZINK Material and Processing Guidelines: latest edition
- 4. SMACNA – Architectural Sheet Metal Manual; latest edition; Chapter 7 as a minimum standard or these specification and details where they exceed.
- 5. Names of the applicable building codes or other authorities having jurisdiction:  

---
- 6. As all documents are intended to be complementary, in the event of contradiction in the references, the RHEINZINK Division 7 Binder; latest edition will govern.

#### 1.04 SUBMITTALS

- A. Product Data: provide zinc manufacturer's product data for zinc sheet material including any fabricator's product specifications, standard details, and installation instructions. Indicate installer's intent for roof tile fabrication by shop fabrication or pre-manufactured zinc tiles.
- B. Installer References: Installer shall submit list of (3) completed "natural metal" roof installations (zinc or copper) of similar scope and complexity.
- C. Material Samples: submit [RHEINZINK-CLASSIC bright rolled, RHEINZINK-prePATINA blue-grey, RHEINZINK-prePATINA graphite-grey, RHEINZINK-GRANUM skygrey, RHEINZINK-GRANUM basalte, RHEINZINK-artCOLOR - various colors and PRISMO – various colors] (Note artCOLOR and PRISMO are premium colors) color samples of each material that is to be exposed in the finished work. As required by architect, also provide two fabricated panel samples to demonstrate connection.
- D. Shop Drawings: show layouts of tiles on all roof plans, location of all roof penetrations, details of tile terminations, edge conditions, joints, corners, tile profiles, supports, anchorages, trim, flashings, closures, and special details. Distinguish between factory and field assembly work. Provide actual dimensions to the greatest extent possible.
  - 1. Details for forming sheet metal components including dimensions.
  - 2. Details for joining and securing sheet metal components, including wood sub framing, clip spacing, fastener requirements, and other attachments.
  - 3. Details of termination points and assemblies, including fixed points.
  - 4. Details of expansion joints, including showing direction of expansion.
  - 5. Details of roof penetrations.
  - 6. Details of edge conditions, including eaves, ridges, valleys, rakes, crickets and counter flashings.
  - 7. Details of special conditions, integrating mechanical, electrical and plumbing conditions.
  - 8. Details of connections to adjoining work
  - 9. Details of the following accessory items, at a scale of not less than 1 ½ inches per 12 inches:
    - a. Flashing and Trim
    - b. Fin Gutters
    - c. Gutters including outlet locations and expansion joints
    - d. Downspouts
    - e. Snow Guards
    - f. Roof Access Steps
    - g. Safety Line Attachments
- E. [Engineering Calculations: As required by Architect, Installer to provide wind load (positive and negative pressure) calculations based on substrate [exterior sheathing, galvanized steel sub-framing] information provided by the Contractor. Calculations to utilize fastener pullout data and known panel physical properties to provide "estimated" design performance. Submit written certification showing calculations prepared and stamped by a Professional Structural Engineer licensed and registered in the project state.]

#### 1.05 QUALITY ASSURANCE

- A. Fabricator/Installer Qualifications: The fabricator and installer of the wall panel system shall be trained by the zinc material manufacturer [and system fabricator]. Installer shall submit list of three (3) successful "natural metal" project installations of similar complexity and scope.

- B. Source: Provide panels, which are the product of one manufacturer. Provide secondary materials, which are acceptable to the zinc manufacturer. Award installation of zinc roof panels, including weather-barrier underlayment to a single firm for undivided responsibility.
- C. Comply with RHEINZINK Division 7 Binder; latest edition and SMACNA-Architectural Sheet Metal Manual; latest edition for flashings and sheet metal work.
- D. Field Measurements: Prior to fabrication of roof tile and flashing, take field measurements of structure or substrates to ensure proper fit and alignment.
- E. Pre-Installation Conference: Two weeks prior to commencement of work, convene an installation conference to include the Architect, General Contractor and Zinc roof Installer in order to establish procedures to maintain optimum working conditions and to coordinate this work with related and adjacent work.
  - 1. Review methods and procedures for installation including, but not limited to: substrates, subframing, drains, curbs, and penetrations.
  - 2. Review drawings, specifications, & roof submittals.
  - 3. Review construction schedule verifying availability of all materials, personnel and equipment needed to proceed and avoid delays.
  - 4. Review weather and forecasted weather conditions and procedures for coping with unfavorable conditions, including cold temperatures and temporary roofing.
- F. Mock-Up: As determined by the architect, Contractor to provide roof carpentry for mockup ready for zinc roof panel installation. Incorporate materials and methods of fabrication and installation identical with project requirements. Install mock-up at roof area location directed by Architect. Retain accepted mock-up as quality standard for acceptance of completed metal roofing. As appropriate, mock-up may be incorporated as part of final metal roofing work.
  - 1. Provide mock-up of sufficient size and scope to show panel width/length, edge construction, a sample of soldering (where required) and finish texture and color.
  - 2. Provide mock-up of gutter and eave assembly.
  - 3. Extent of mock-ups is indicated on the Drawings.
  - 4. Obtain Architect's written approval of mock-ups prior to proceeding.
- G. Soldering: In accordance with zinc manufacturer's instructions.
- H. Corrosion Control: Contractor to avoid direct contact of incompatible materials including but not limited to copper, red rosin paper and masonry cleaning solutions.

#### **1.06 PERFORMANCE REQUIREMENTS**

- A. Design roof assembly to conform to the requirements of the \_\_\_\_\_ Building Code.
- B. Minimum roof slope/pitch is 3° (5/8":12) with conditions
- C. Install sheet metal roofing panels and underlayment system capable of withstanding exposure to weather without failure or infiltration of water into the building interior.
- D. Wind Load: Design and engineer sheet metal roof assemblies, including size and spacing of attachment devices, meeting requirements of local building codes.
- E. Thermal Movement: Provide systems and detail connections which allow for thermal movement resulting from ambient temperature range of -4° F to 176° F.
- F. Structural Performance: Provide metal panels, anchors and attachments which resist loads required by code and loads as indicated on the Drawings without permanent deflection or deformation. Information on Drawings referring to specific design of attachment, panel stiffening, and structural systems is intended for information only. System performance, based on project

conditions and compliance with all applicable codes and loading requirements, shall be the responsibility of the panel fabricator and installer.

## **DELIVERY, STORAGE AND HANDLING**

- A. Deliver materials and products in unopened factory labeled packages. Protect from all possible damage. All zinc sheet, coil, and shop fabricated panels to be crated and transported according to zinc manufacturer's and fabricator's recommendations.
- B. Store and handle in strict compliance with zinc manufacturer's instructions and recommendations.
  - 1. Stack materials on platforms or pallets, covered with tarpaulins or other suitable weather tight ventilated covering. Slope cover to shed moisture. Allow for free air flow around covered material to exchange outside air.
  - 2. Require all personnel to wear clean white cotton gloves when handling and installing zinc panels and accessories when no strippable film is present.
  - 3. Do not store panels in contact with other materials that might cause staining, denting, or other surface damage.
  - 4. Store all zinc panels & flashings so that they will not accumulate water.
- C. Exercise care in unloading, storing, and erecting panels to prevent bending, warping, or surface damage.
- D. Sequence deliveries to avoid delays, but minimize on-site storage.
- E. Contractor to deny other trades onto finished roof without permission of zinc installer. Installer to limit unnecessary walking on finished roof. Require all personnel to wear uncontaminated, clean, rubber soled shoes when installing or walking on roof.

### **1.07 WARRANTY**

- A. Material Only Warranty: provide X-year limited warranty for Titanium-Zinc alloy from original rolling mill manufacturer. Warranty to cover the material quality of the sheet/ coil material used to fabricate sheet metal flashing & trim profiles appropriate for zinc installation.
- B. Fabrication Warranty: provide X-year fabrication warranty against sharp bends that fracture the metal, tears, and equipment induced damage to the Architectural Zinc sheet or coil.
- C. Installation Warranty: provide X-year guarantee covering the proper material or product application preventing failure due to hot-water corrosion, damage due to inappropriate slip sheet, absorptive separation material, or other installer induced failure.

## **PART 2 – PRODUCTS**

### **2.01 MANUFACTURERS**

- A. Approved Zinc Manufacturer: Subject to compliance with requirements, manufacturers offering metal roof or wall panel materials that may be incorporated in the work include:
  - 1. RHEINZINK America, Inc.  
Woburn, MA 01081 ph: (781) 729.0812  
Regional Sales Manager: \_\_\_\_\_ ph: \_\_\_\_\_  
[www.rheinzink.us](http://www.rheinzink.us), [info@rheinzink.com](mailto:info@rheinzink.com)
- B. Zinc Alloy Sheet/Coils:
  - 1. Titanium Zinc Alloy whose base is electrolytic high grade with a 99.995 % Zn degree of purity and alloying additives of 0.08% - 1.0% copper and 0.07% - .12% titanium, .001% -

.015% aluminum in accordance with ASTM B69-16 (or latest edition) – Architectural Rolled Zinc - Type 1 and Type 2.

- a. RHEINZINK-CLASSIC bright rolled
  - b. RHEINZINK-prePATINA: pickling process
    - 1. blue-grey
    - 2. graphite-grey
  - c. RHEINZINK-GRANUM: phosphating process
    - 1. sky-grey
    - 2. basalte
  - d. RHEINZINK-artCOLOR: PVDF finish
    - 1. various colors
    - 2. ProRoofing backside coating
  - e. RHEINZINK-PRISMO - PVDF finish
    - 1. various colors
    - 2. ProRoofing backside coating
- C. Standing Seam panels require a minimum of 5/8:12 pitch.
- a. **Double Lock Standing Seam: Low Slope** (<3:12): Require both ProRoofing and Air-Z (or Enkamat 7008 or 7010).
  - b. **Double Lock Standing Seam: Mid Slope** (3:12 to 6:12): Require Air-Z (or Enkamat 7008 or 7010).
  - c. **Double Lock or Angled Lock Standing Seam: Steep Slope** (>6:12): Require Air-Z (or Enkamat 7008 or 7010).
- 2. Minimum Panel Thickness: [0.7mm (24 ga.), 0.8 mm (22 ga.), 1.0 mm (20 ga.)]
  - 3. Minimum Flashing Thickness: 0.7 mm (24 ga.)
- B. Panel Fabricator or System Manufacturer:
- 1. Local / Regional Sheet Metal Fabrication Shop:
    - a. Select roof tile fabricator that has the equipment and personnel capable of providing quality zinc roof panels as indicated on the drawings.
    - b. Installer's option to purchase prefabricated wall panels as provided by an approved and experienced RHEINZINK system partner or fabricator.

## 2.02 PROFILES

### A. Mechanical Double Lock Seam

- 1. Panel seam height: 1" – 1 1/2"
- 2. Pan width/ seam spacing:  $\pm 15 \frac{1}{2}" - 16 \frac{1}{2}"$  (panel is made from a  $\frac{1}{2}$  meter coil 19.7").

## 2.03 ACCESSORIES

- A. Provide all components necessary for a complete, functional, weatherproof assembly including, but not limited to, trims, copings, fascias, sills, flashings, counter flashings, door frame trim, corner units, clips, wall caps, copings, sealants, closures and fillers. Metal materials shall match panels and be zinc compatible.
- B. Clips & Fasteners: Provide stainless steel concealed clips and fasteners; supplied in accordance with manufacturer's recommendations and to meet the load requirements as specified by architect and confirmed by engineering calculations. When using AIR-Z by RHEINZINK or Enkamat (7008 or 7010) by Bonar, Enka, NC. Use clips that are  $\frac{1}{4}"$  taller than the seam or a shim between the clip and the AIR-Z or Enkamat.

- C. Roof structured mat (capillary break): As indicated on drawings (but not required on façade applications), provide manufacturer's approved nylon, non-woven, structured mat equal to AIR-Z by RHEINZINK or Enkamat (7008 or 7010) by Bonar, Enka, NC.
- D. Self-adhered Waterproof Underlayment: non-permeable self-adhering, high-temperature composite, butyl rubber-based, polyethylene-backed membrane such as GRACE Ultra™ or other high-temperature rubberized-asphalt sheet.
- E. Permeable Underlayment: Permeable breather type underlayment membrane: SLOPESHEILD PLUSas manufactured by VaproShield (note taped joints & fastener gasket requirement).
- F. Synthetic Underlayment: Low-perm film used as substitute. Manufactured in large sheets to minimize seams. Provide RoofTopGuard II, TriFlex 30 or equal
- G. Solder: Lead solder containing 50% tin and 50% lead in accordance with ASTM B32 – 08 (or latest edition) or lead-free solder. Flux: Felder ZD-Pro or equal.
- H. Sealants:
  - 1. Joint Sealant: DOW 795, or other documented pH neutral sealant
  - 2. Backer rod shall be extruded polyethylene foam as DOW ETHAFOAM SB or equal.
- I. Snow Guards: S-5! or consult manufacturer.

#### **2.04 PANEL & FLASHING FABRICATION**

- A. General: Custom fabricate sheet metal panels to comply with details shown and recommendations in SMACNA's "Architectural Sheet Metal Manual" and RHEINZINK Division 7 Binder; Latest Edition that apply to the design, dimensions (pan width and depth), geometry, metal thickness, and other characteristics of installation indicated. Shop fabricates sheet metal wall panels and accessories at the shop to the greatest extent possible.
  - 1. Standing-Seam Roofing Panels: Form standing-seam pans from continuous metal sheets, with male and female dimensions to manufacturer's specifications.
  - 2. Provide backside coated zinc or other permanent separation materials on concealed panel or flashing surfaces where panels or flashings would otherwise be in direct contact with substrate materials that are non-compatible or could result in corrosion or deterioration of either material or finishes.
- A. Fabricate sheet metal roofing panels to allow for expansion in running work sufficient to prevent leakage, damage, and deterioration of the Work. Form exposed sheet metal work to fit substrates without excessive oil canning, buckling, and tool marks, true to line and levels indicated, and with exposed edges folded back to form hems.
  - 1. Form and fabricate sheets, seams, strips, cleats, edge treatments, integral flashing, and other components of metal roofing to profiles, patterns, and drainage arrangements shown and as required to resist Water infiltration without excessive use of sealants (dry Joints) while also allowing any water infiltration behind the roof panels to weep out.
- B. Expansion Provisions: Where lapped or bayonet-type expansion provisions in the Work cannot be used, form expansion joints of intermeshing hooked flanges, not less than 1 inch deep, and filled with non-acidic sealant (concealed within joints) if determined to be necessary for weather-tight detail (dry joints are often acceptable).
- C. Sealant Joints: Where movable, non-expansion-type joints are indicated or required to produce weather tight seams, form metal to provide for proper installation of elastomeric sealant in compliance with SMACNA standards. In general, panel joints are intended to be dry, sealant-free, to facilitate air movement and drying behind the roof panels.

## **PART 3 – EXECUTION**

### **3.01 INSPECTION**

- A. Contractor shall inspect all surfaces, areas and other contingent construction in or to which his work is to be installed and insure himself that they are in proper condition to receive the work to be performed under this Section.
- A. Verify that sheathing surfaces are sound, dry, properly secured and that provision has been made for flashings, anchorage, and all other interface items attaching to or penetrating through the Work of this Section.
- B. To the greatest extent possible, Contractor and Installer shall inspect roof deck before roof underlayment is applied. Installer shall notify the Contractor of any deck, penetration, or other substrate condition requiring corrective action.

### **3.02 PREPARATION**

- A. Verify field dimensions before fabrication. Notify Architect of any discrepancies between field measurements and dimensions indicated in Construction Documents.
- B. Place [permeable, synthetic, waterproof] underlayment membrane and venting mat on substrate surfaces to receive metal panels; comply with manufacturer's instructions.
  - 1. Coordinate installation of underlayment with metal roofing, rain drainage work, flashing, trim and construction of parapets, walls, and other adjoining work to provide a weatherproof, secure and non-corrosive installation.
  - 2. For underlayment end-laps and side-laps, see underlayment manufacturer's instructions for proper attachment, seaming, and termination recommendations.
  - 3. Apply weather barrier underlayments parallel to the eave.
- C. For loose-laid mechanically attached sheets, consult the architect for strategies preventing moisture infiltration through fastener holes. Potential solutions include: applying sealant or self-adhered gaskets to backside of clips.

### **3.03 FIELD FABRICATION**

- A. Form panels and flashings in shop to greatest extent possible. Field modify only as necessary.
- B. Ensure material temperature has moderated above 48 degrees F. prior to field fabrication.
- C. Cut prefabricated zinc panels, and flashing with smooth (non-serrated) blade shears and snips. Bend zinc so that there are properly sized radius bends. Inspect initial panel and flashing bends to ensure material cracking has not occurred.
- D. Form rounded cuts and notches as made by MASC notching tool and demonstrated during zinc manufacturer fabrication training. Rounded cuts & notches are also possible by cutting to a predrilled hole.

### **3.04 INSTALLATION**

- A. Manufacturer's Recommendations: Except as otherwise shown or specified, comply with Recommendations and instructions of manufacturer of sheet metal being fabricated and installed.



1. Do not install in inclement weather
  2. Do not install over a damp substrate
  3. Do not install when inclement weather is threatening.
  4. If covering of zinc panels is required, provide free air flow around the zinc material to manufacturer's requirement to prevent white rust.
- B. Install work to be truly straight and square or conform to curvilinear geometry indicated on drawings.
1. Fabricate and install work with lines and corners of exposed units true and accurate.
  2. Form exposed faces free of buckles, excessive waves, and avoidable tool marks considering temper and reflectivity of metal.
  3. Shim and align panel units within installed tolerance of ¼ inch in 20' -0"
  4. All seams shall be of uniform appearance and dimensions, straight and level with minimum exposure of solder and sealant.
  5. Except as otherwise shown, fold back sheet metal to form a hem on concealed side of exposed edges.
  6. Form all seams to be weatherproof, leaving room for expansion and contraction with specified and required tolerances.
  7. Comply with RHEINZINK Division 7 Binder; latest edition and SMACNA Architectural Sheet Metal Manual; latest edition, for flashings and sheet metal work.
- C. Conceal fasteners and expansion provision where possible in exposed work, and locate so as to minimize possibility of leakage. Cover and seal fasteners and anchors as required for a tight installation.
- D. To avoid material tearing, provide cuts with rounded notching tool or cut to pre-drilled hole. Only use smooth edge (non-serrated) shears and snips for zinc cutting.
- E. Provide indirect attachment of exposed zinc with concealed "keeper" whenever possible. Avoid exposed and direct fastening especially at lap locations to allow movement.
- F. Provide work as indicated on approved shop drawings
1. Form and fabricate sheets, seams, strips, cleats, edge treatments, integral flashings, and other components of metal wall cladding to profiles, patterns, and drainage arrangements shown and as required for water shedding construction. Ensure that all shop & field fabricated bends have an acceptable "rounded" or radius bend. NO SHARP BREAKS.
- G. Separate non-compatible materials with a rubberized asphalt underlayment.
- H. Install work to meet specified performance requirements.

### **3.05 CLEANING AND PROTECTION**

- A. Remove protective film (if any) from exposed surfaces of metal roofing promptly upon installation (or prior if film covers any concealed seam areas) with care to avoid damage to finish and in accordance with manufacturer's recommendations.
- B. Clean exposed metal surfaces of substances that would interfere with uniform oxidation and weathering and as recommended by panel manufacturer and maintain in a clean condition during construction. Never apply cleaner directly to zinc surface.
- C. Ensure that cleaning by other trades working in proximity to zinc installation is in accordance with the recommendations of the zinc manufacturer.
- D. Damaged units: Replace panels and other components of the work that have been damaged or have deteriorated beyond successful repair by means of finish touch-up or similar minor repair.
- E. For more complete instructions, please refer to RHEINZINK cleaning recommendations.

**3.06 RECYCLING**

- A. Collect all zinc drop-offs (scrap) and return to local scrap metal recycling facility for current market cash return.

**3.07 CLEAN-UP**

- A. During the progress of the work, keep premises clear of debris resulting from this operations and remove surplus and waste materials from the site as soon as possible.
- B. Upon completion of the work, Contractor shall remove from the site all equipment and materials used on the work as well as any debris resulting from the operations.

**-END OF SECTION-**