



RHEINZINK America, Inc.

STANDING SEAM FACADE DETAILS - VERTICAL

INDEX OF DRAWINGS

STANDARD DETAILS:

- SSF-V-1a - HEAD DETAIL
- SSF-V-2a - JAMB DETAIL - OPTION 1
- SSF-V-2b - JAMB DETAIL - OPTION 2
- SSF-V-2c - JAMB DETAIL - OPTION 3
- SSF-V-3a - SILL DETAIL - OPTION 1
- SSF-V-3b - SILL DETAIL - OPTION 2
- SSF-V-4a - OUTSIDE CORNER DETAIL - OPTION 1
- SSF-V-4b - OUTSIDE CORNER DETAIL - OPTION 2
- SSF-V-5a - INSIDE CORNER DETAIL - OPTION 1
- SSF-V-5b - INSIDE CORNER DETAIL - OPTION 2
- SSF-V-6a - BASE TERMINATION DETAIL
- SSF-V-7a - PARAPET DETAIL - OPTION 1
- SSF-V-7b - PARAPET DETAIL - OPTION 2
- SSF-V-8 - HORIZONTAL SEAM DETAIL
- SSF-V-9 - VERTICAL SEAM DETAIL
- SSF-V-10 - PANEL & SEAM PROFILE

CUSTOM DETAILS:

- SSF-V-1b - HEAD DETAIL
- SSF-V-6b - BASE TERMINATION DETAIL
- SSF-V-7c - PARAPET DETAIL

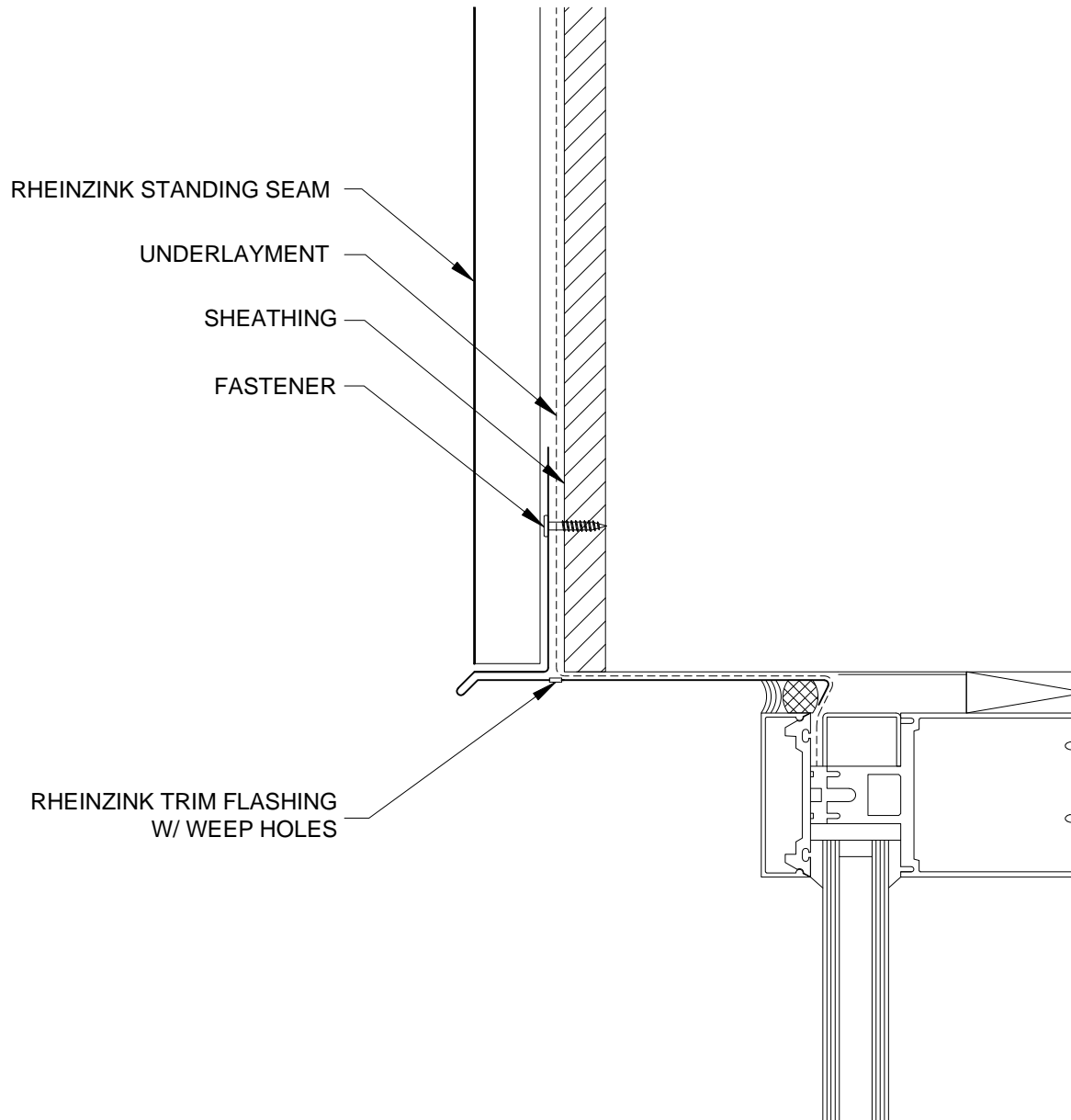

NOTES:

1. RHEINZINK RECOMMENDS STAINLESS STEEL FASTENERS AND CLIPS.
2. ZINC CLIPS MAY BE USED ON FACADES.



Website: www.rheinzink.us E-mail: info@rheinzink.com

INFORMATION AND DETAILS HEREIN ARE ONLY A BASELINE FOR SYSTEM DESIGN AND INSTALLATION. MODIFICATION TO MEET PROJECT REQUIREMENTS IS THE RESPONSIBILITY OF THE DESIGNER AND ARCHITECT. RHEINZINK AMERICA STAFF ARE AVAILABLE TO ASSIST THE DESIGNER AND ARCHITECT IN THIS PROCESS. RHEINZINK AMERICA MAKES NO REPRESENTATIONS AND WARRANTIES OTHER THAN THOSE EXPRESSED HEREIN.

PROJECT:	STAND. SEAM FACADE DETAILS - V	DATE:	08-2011
DRAWING TITLE:	HEAD DETAIL - OPT. 1	SCALE:	N.T.S.
COPYRIGHT RESERVED. THIS DRAWING REMAINS THE PROPERTY OF RHEINZINK.		SHEET:	SSF-V-1a

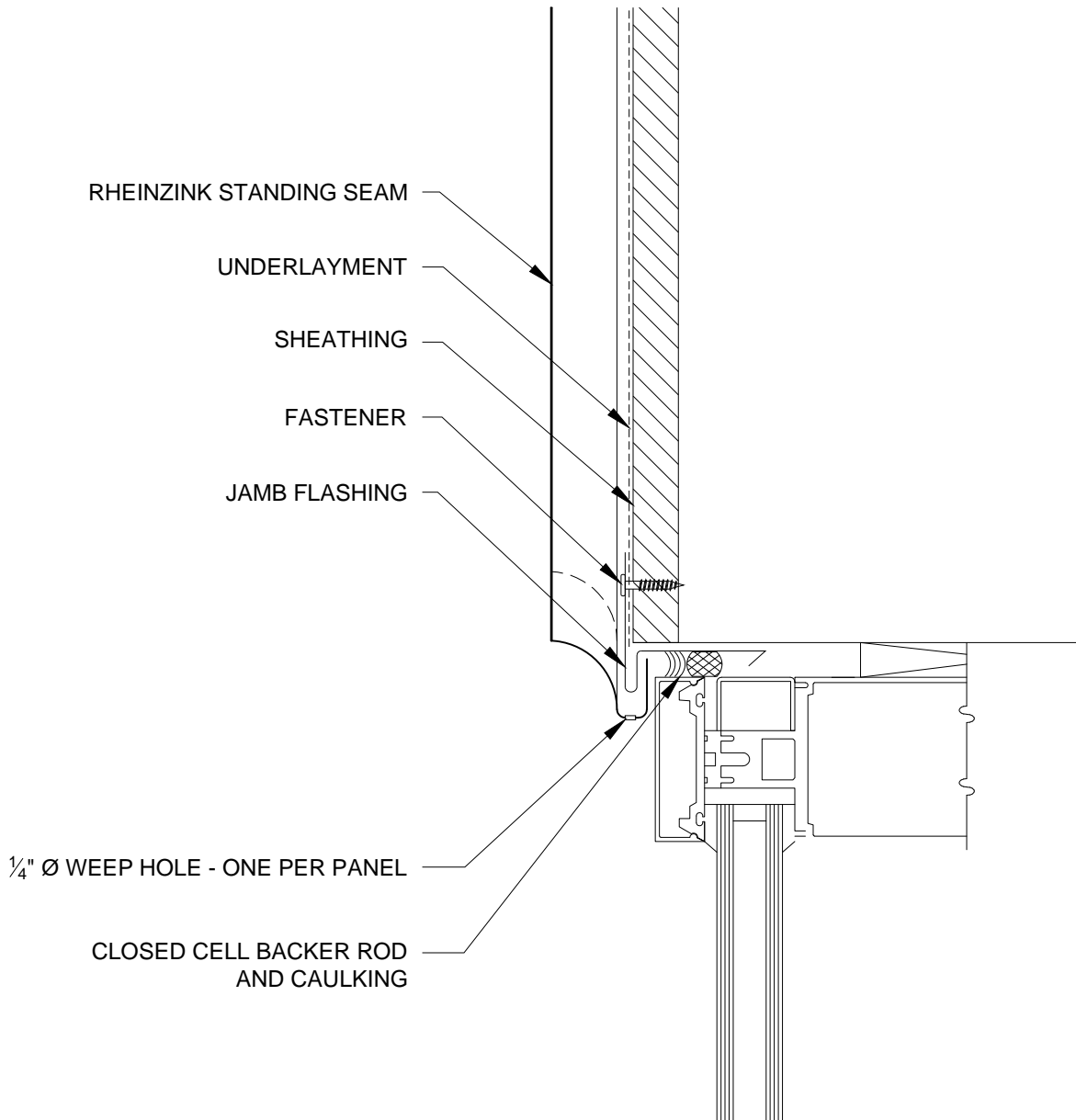

NOTES:

1. RHEINZINK RECOMMENDS STAINLESS STEEL FASTENERS AND CLIPS.
2. ZINC CLIPS MAY BE USED ON FACADES.



Website: www.rheinzink.us E-mail: info@rheinzink.com

INFORMATION AND DETAILS HEREIN ARE ONLY A BASELINE FOR SYSTEM DESIGN AND INSTALLATION. MODIFICATION TO MEET PROJECT REQUIREMENTS IS THE RESPONSIBILITY OF THE DESIGNER AND ARCHITECT. RHEINZINK AMERICA STAFF ARE AVAILABLE TO ASSIST THE DESIGNER AND ARCHITECT IN THIS PROCESS. RHEINZINK AMERICA MAKES NO REPRESENTATIONS AND WARRANTIES OTHER THAN THOSE EXPRESSED HEREIN.

PROJECT:	STAND. SEAM FACADE DETAILS - V	DATE:	08-2011
DRAWING TITLE:	HEAD DETAIL - OPT. 2	SCALE:	N.T.S.
COPYRIGHT RESERVED. THIS DRAWING REMAINS THE PROPERTY OF RHEINZINK.		SHEET:	SSF-V-1b

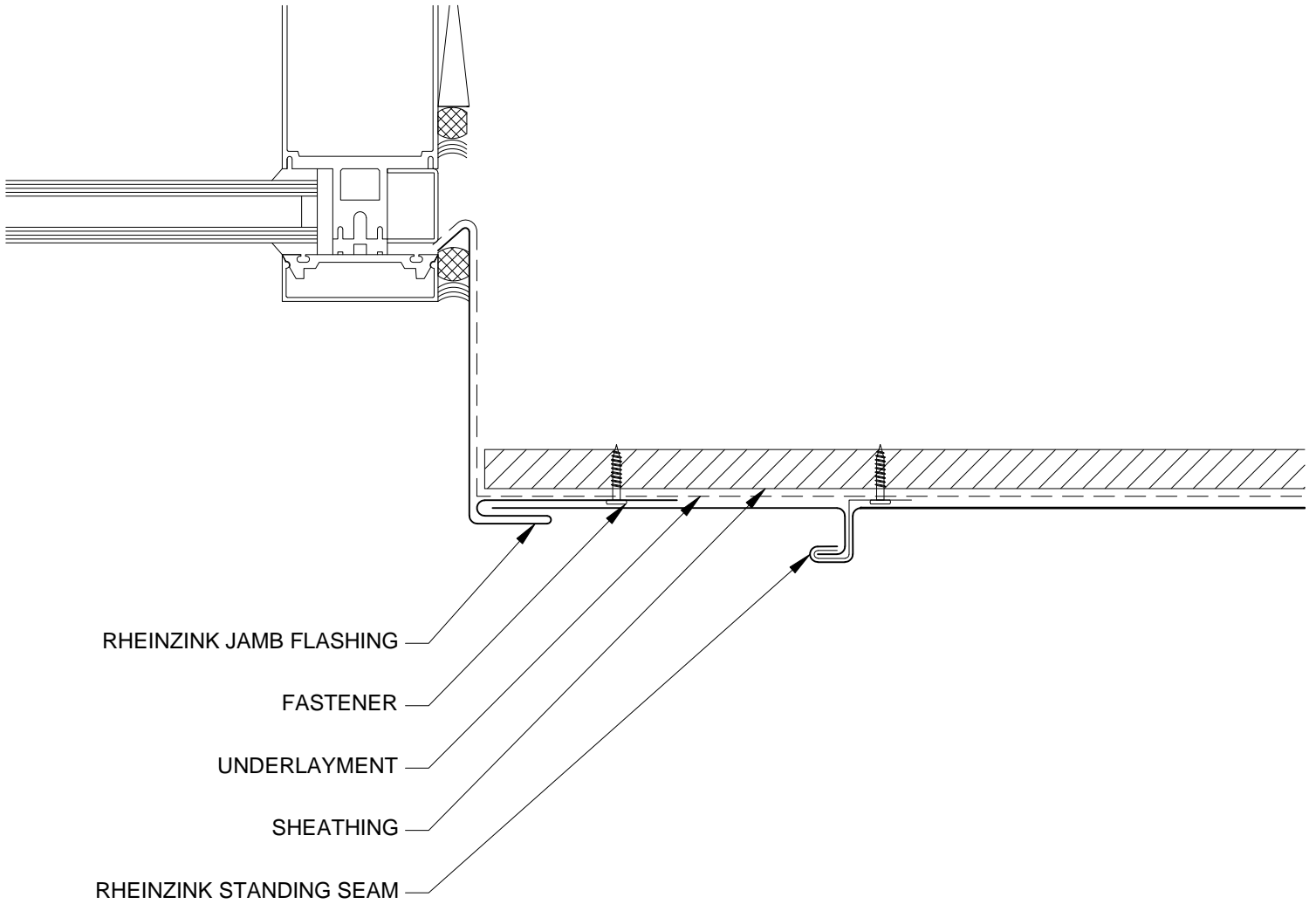

NOTES:

1. RHEINZINK RECOMMENDS STAINLESS STEEL FASTENERS AND CLIPS.
2. ZINC CLIPS MAY BE USED ON FACADES.



Website: www.rheinzink.us E-mail: info@rheinzink.com

INFORMATION AND DETAILS HEREIN ARE ONLY A BASELINE FOR SYSTEM DESIGN AND INSTALLATION. MODIFICATION TO MEET PROJECT REQUIREMENTS IS THE RESPONSIBILITY OF THE DESIGNER AND ARCHITECT. RHEINZINK AMERICA STAFF ARE AVAILABLE TO ASSIST THE DESIGNER AND ARCHITECT IN THIS PROCESS. RHEINZINK AMERICA MAKES NO REPRESENTATIONS AND WARRANTIES OTHER THAN THOSE EXPRESSED HEREIN.

PROJECT:	STAND. SEAM FACADE DETAILS - V	DATE:	10-2011
DRAWING TITLE:	JAMB DETAIL - OPT. 1	SCALE:	N.T.S.
COPYRIGHT RESERVED. THIS DRAWING REMAINS THE PROPERTY OF RHEINZINK.		SHEET:	SSF-V-2a

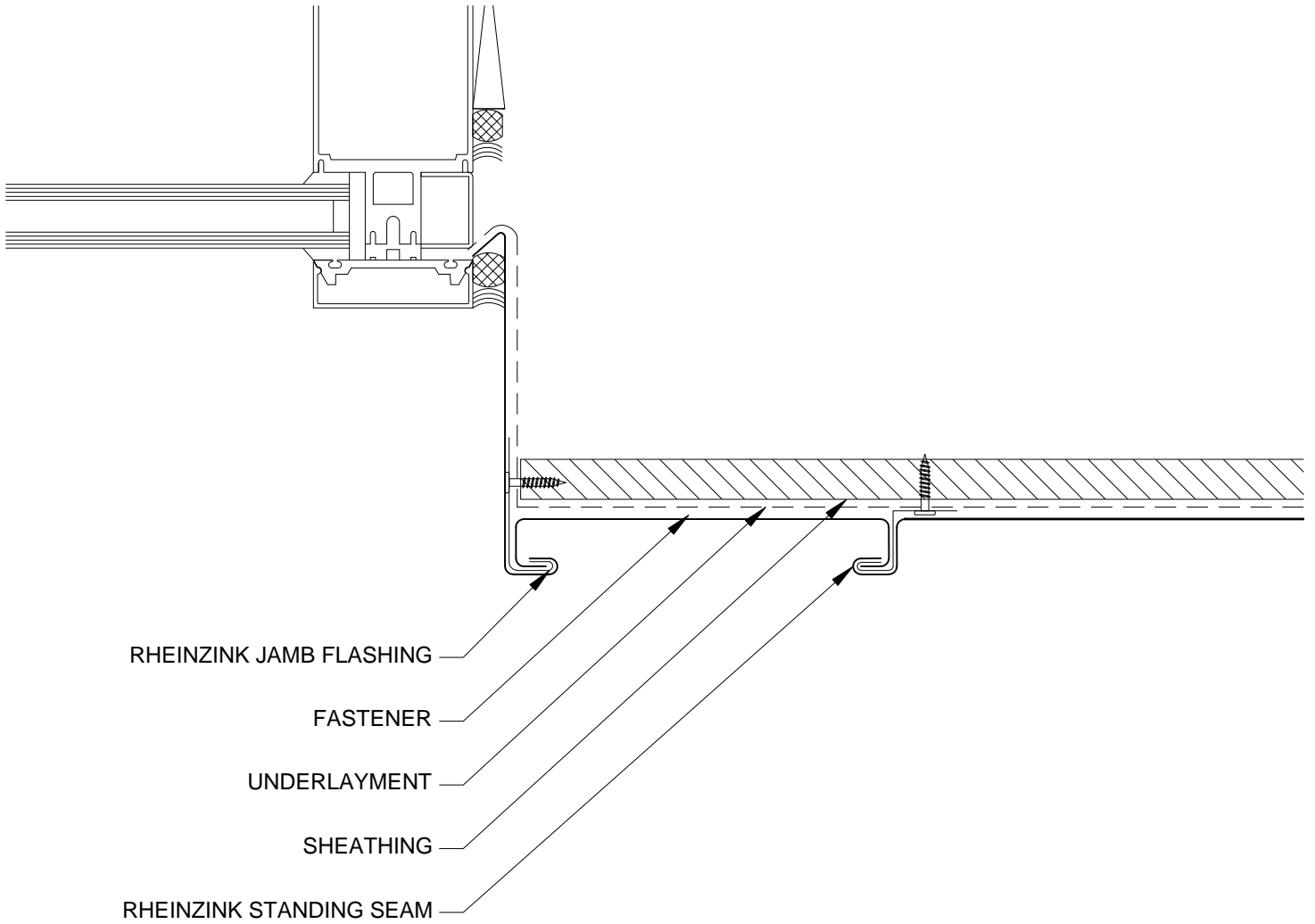

NOTES:

1. RHEINZINK RECOMMENDS STAINLESS STEEL FASTENERS AND CLIPS.
2. ZINC CLIPS MAY BE USED ON FACADES.



Website: www.rheinzink.us E-mail: info@rheinzink.com

INFORMATION AND DETAILS HEREIN ARE ONLY A BASELINE FOR SYSTEM DESIGN AND INSTALLATION. MODIFICATION TO MEET PROJECT REQUIREMENTS IS THE RESPONSIBILITY OF THE DESIGNER AND ARCHITECT. RHEINZINK AMERICA STAFF ARE AVAILABLE TO ASSIST THE DESIGNER AND ARCHITECT IN THIS PROCESS. RHEINZINK AMERICA MAKES NO REPRESENTATIONS AND WARRANTIES OTHER THAN THOSE EXPRESSED HEREIN.

PROJECT:	STAND. SEAM FACADE DETAILS - V	DATE:	10-2011
DRAWING TITLE:	JAMB DETAIL - OPT. 2	SCALE:	N.T.S.
COPYRIGHT RESERVED. THIS DRAWING REMAINS THE PROPERTY OF RHEINZINK.		SHEET:	SSF-V-2b

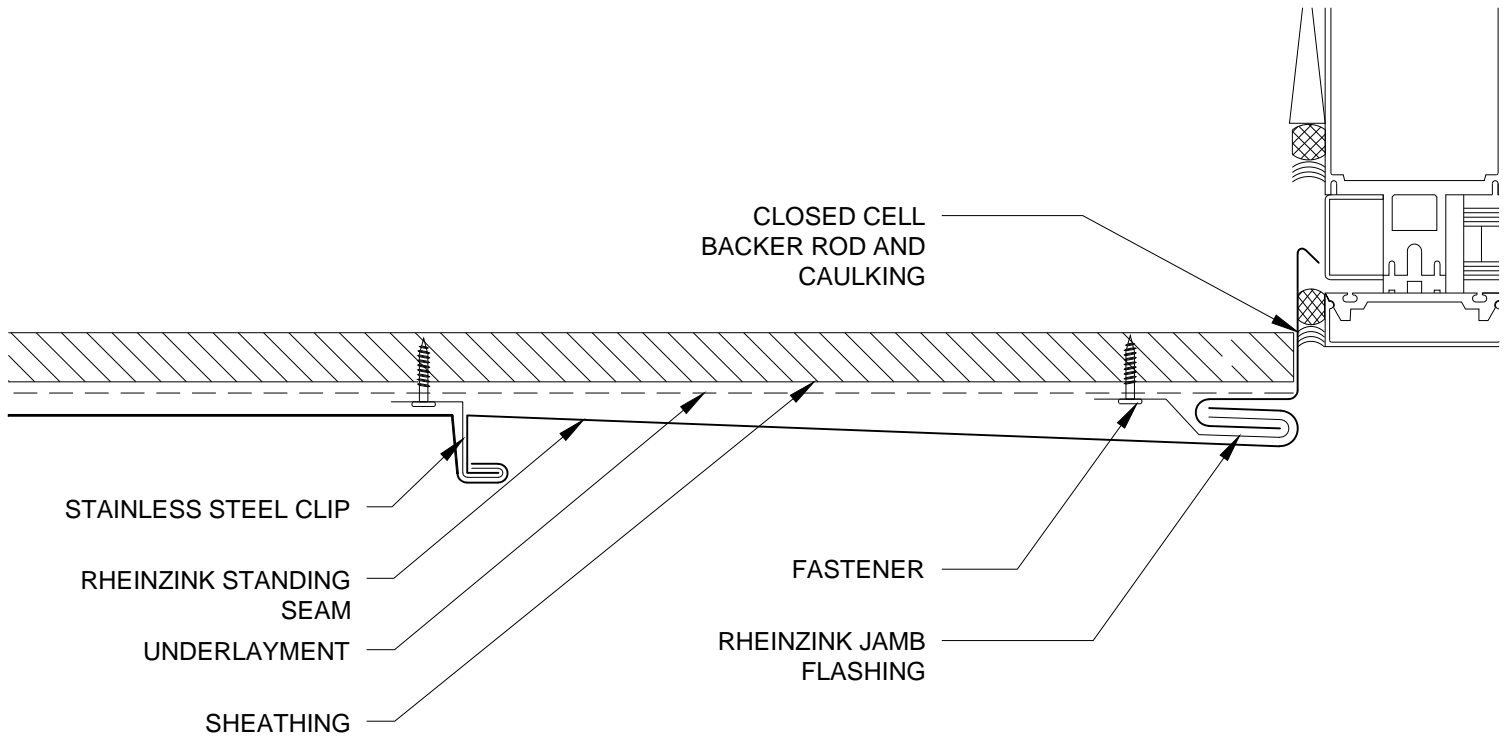

NOTES:

1. RHEINZINK RECOMMENDS STAINLESS STEEL FASTENERS AND CLIPS.
2. ZINC CLIPS MAY BE USED ON FACADES.

 Website: www.rheinzink.us E-mail: info@rheinzink.com	
INFORMATION AND DETAILS HEREIN ARE ONLY A BASELINE FOR SYSTEM DESIGN AND INSTALLATION. MODIFICATION TO MEET PROJECT REQUIREMENTS IS THE RESPONSIBILITY OF THE DESIGNER AND ARCHITECT. RHEINZINK AMERICA STAFF ARE AVAILABLE TO ASSIST THE DESIGNER AND ARCHITECT IN THIS PROCESS. RHEINZINK AMERICA MAKES NO REPRESENTATIONS AND WARRANTIES OTHER THAN THOSE EXPRESSED HEREIN.	
PROJECT: STAND. SEAM FACADE DETAILS - V	DATE: 08-2011
DRAWING TITLE: JAMB DETAIL - OPT. 3	SCALE: N.T.S.
COPYRIGHT RESERVED. THIS DRAWING REMAINS THE PROPERTY OF RHEINZINK.	SHEET: SSF-V-2c

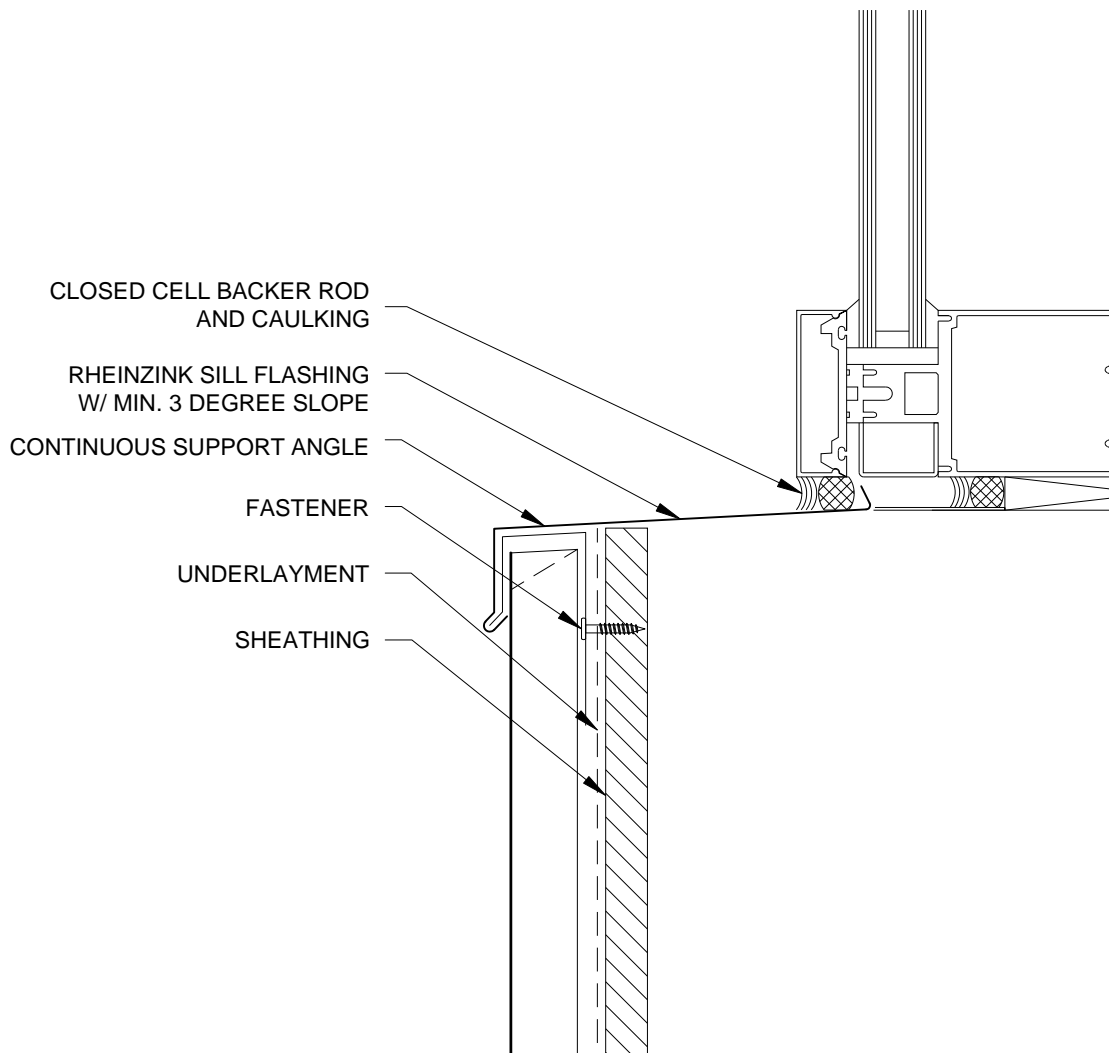

NOTES:

1. RHEINZINK RECOMMENDS STAINLESS STEEL FASTENERS AND CLIPS.
2. ZINC CLIPS MAY BE USED ON FACADES.



Website: www.rheinzink.us E-mail: info@rheinzink.com

INFORMATION AND DETAILS HEREIN ARE ONLY A BASELINE FOR SYSTEM DESIGN AND INSTALLATION. MODIFICATION TO MEET PROJECT REQUIREMENTS IS THE RESPONSIBILITY OF THE DESIGNER AND ARCHITECT. RHEINZINK AMERICA STAFF ARE AVAILABLE TO ASSIST THE DESIGNER AND ARCHITECT IN THIS PROCESS. RHEINZINK AMERICA MAKES NO REPRESENTATIONS AND WARRANTIES OTHER THAN THOSE EXPRESSED HEREIN.

PROJECT:	STAND. SEAM FACADE DETAILS - V	DATE:	10-2011
DRAWING TITLE:	SILL DETAIL - OPT. 1	SCALE:	N.T.S.
COPYRIGHT RESERVED. THIS DRAWING REMAINS THE PROPERTY OF RHEINZINK.		SHEET:	SSF-V-3a

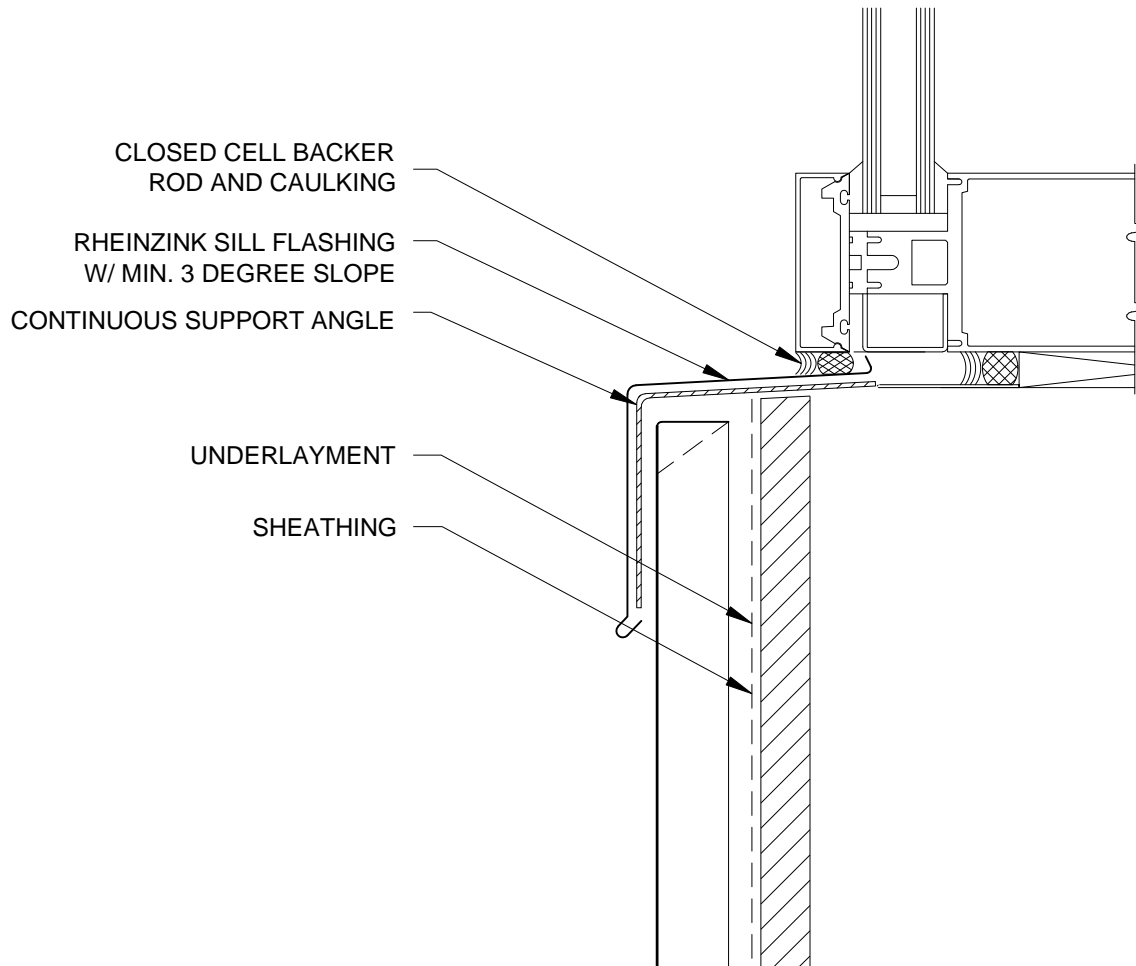

NOTES:

1. RHEINZINK RECOMMENDS STAINLESS STEEL FASTENERS AND CLIPS.
2. ZINC CLIPS MAY BE USED ON FACADES.



Website: www.rheinzink.us E-mail: info@rheinzink.com

INFORMATION AND DETAILS HEREIN ARE ONLY A BASELINE FOR SYSTEM DESIGN AND INSTALLATION. MODIFICATION TO MEET PROJECT REQUIREMENTS IS THE RESPONSIBILITY OF THE DESIGNER AND ARCHITECT. RHEINZINK AMERICA STAFF ARE AVAILABLE TO ASSIST THE DESIGNER AND ARCHITECT IN THIS PROCESS. RHEINZINK AMERICA MAKES NO REPRESENTATIONS AND WARRANTIES OTHER THAN THOSE EXPRESSED HEREIN.

PROJECT:	STAND. SEAM FACADE DETAILS - V	DATE:	10-2011
DRAWING TITLE:	SIL DETAIL - OPT. 2	SCALE:	N.T.S.
COPYRIGHT RESERVED. THIS DRAWING REMAINS THE PROPERTY OF RHEINZINK.		SHEET:	SSF-V-3b

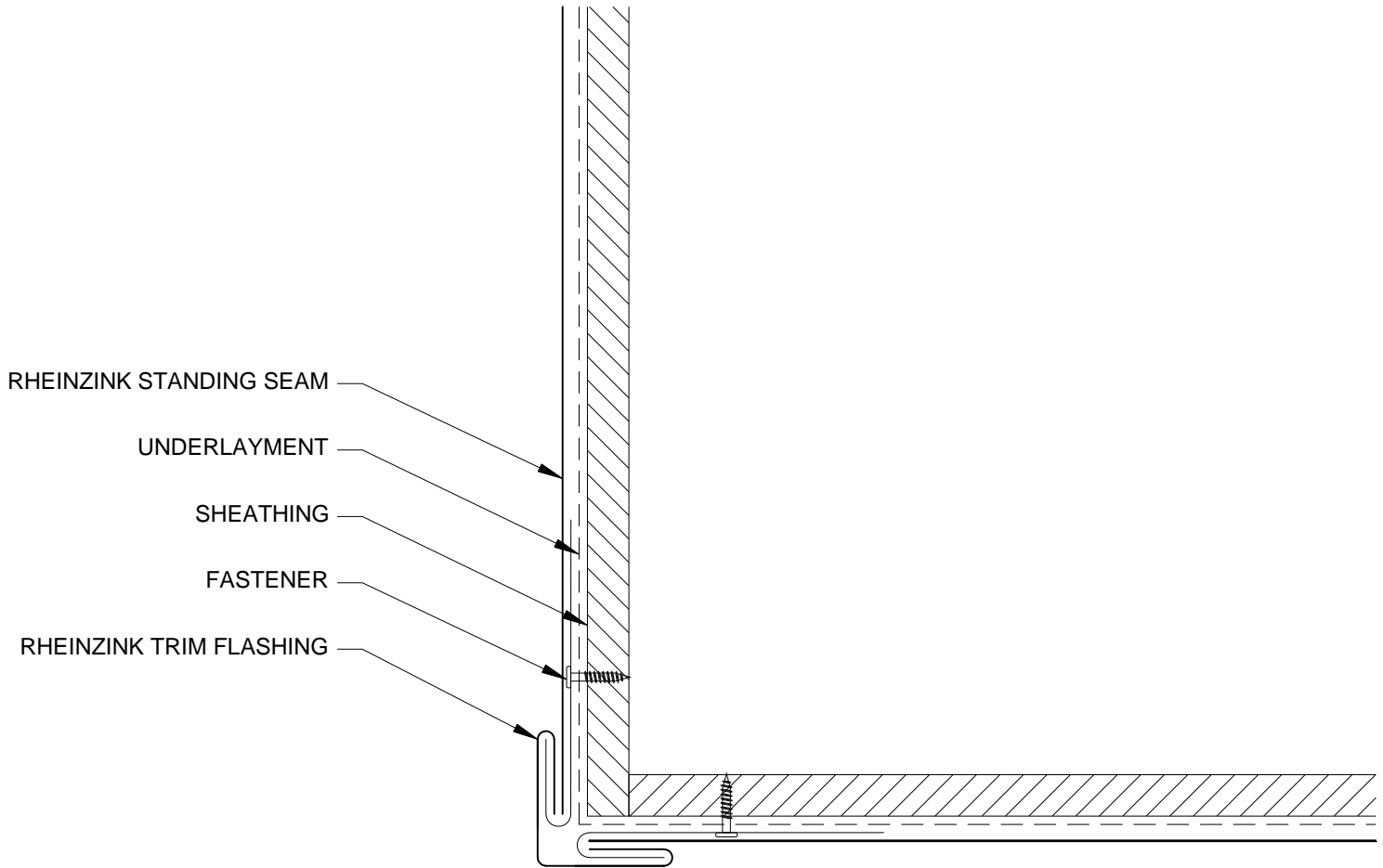

RHEINZINK STANDING SEAM

UNDERLAYMENT

SHEATHING

FASTENER

RHEINZINK TRIM FLASHING

NOTES:

1. RHEINZINK RECOMMENDS STAINLESS STEEL FASTENERS AND CLIPS.
2. ZINC CLIPS MAY BE USED ON FACADES.



Website: www.rheinzink.us E-mail: info@rheinzink.com

INFORMATION AND DETAILS HEREIN ARE ONLY A BASELINE FOR SYSTEM DESIGN AND INSTALLATION. MODIFICATION TO MEET PROJECT REQUIREMENTS IS THE RESPONSIBILITY OF THE DESIGNER AND ARCHITECT. RHEINZINK AMERICA STAFF ARE AVAILABLE TO ASSIST THE DESIGNER AND ARCHITECT IN THIS PROCESS. RHEINZINK AMERICA MAKES NO REPRESENTATIONS AND WARRANTIES OTHER THAN THOSE EXPRESSED HEREIN.

PROJECT:	STAND. SEAM FACADE DETAILS - V	DATE:	08-2011
DRAWING TITLE:	OUTSIDE CORNER DETAIL - OPT. 1	SCALE:	N.T.S.
COPYRIGHT RESERVED. THIS DRAWING REMAINS THE PROPERTY OF RHEINZINK.		SHEET:	SSF-V-4a

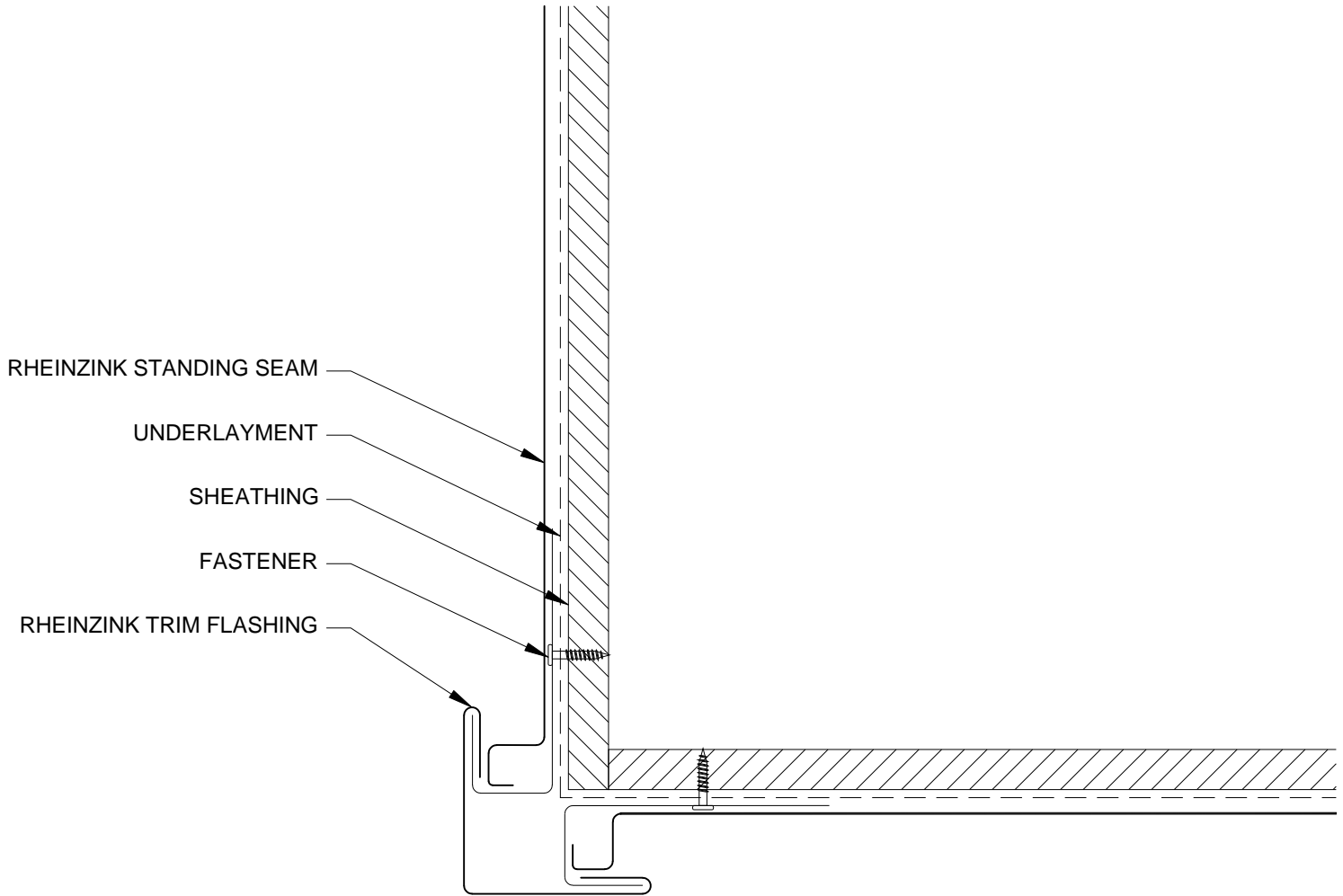

NOTES:

1. RHEINZINK RECOMMENDS STAINLESS STEEL FASTENERS AND CLIPS.
2. ZINC CLIPS MAY BE USED ON FACADES.



Website: www.rheinzink.us E-mail: info@rheinzink.com

INFORMATION AND DETAILS HEREIN ARE ONLY A BASELINE FOR SYSTEM DESIGN AND INSTALLATION. MODIFICATION TO MEET PROJECT REQUIREMENTS IS THE RESPONSIBILITY OF THE DESIGNER AND ARCHITECT. RHEINZINK AMERICA STAFF ARE AVAILABLE TO ASSIST THE DESIGNER AND ARCHITECT IN THIS PROCESS. RHEINZINK AMERICA MAKES NO REPRESENTATIONS AND WARRANTIES OTHER THAN THOSE EXPRESSED HEREIN.

PROJECT:	STAND. SEAM FACADE DETAILS - V	DATE:	08-2011
DRAWING TITLE:	OUTSIDE CORNER DETAIL - OPT. 2	SCALE:	N.T.S.
COPYRIGHT RESERVED. THIS DRAWING REMAINS THE PROPERTY OF RHEINZINK.		SHEET:	SSF-V-4b

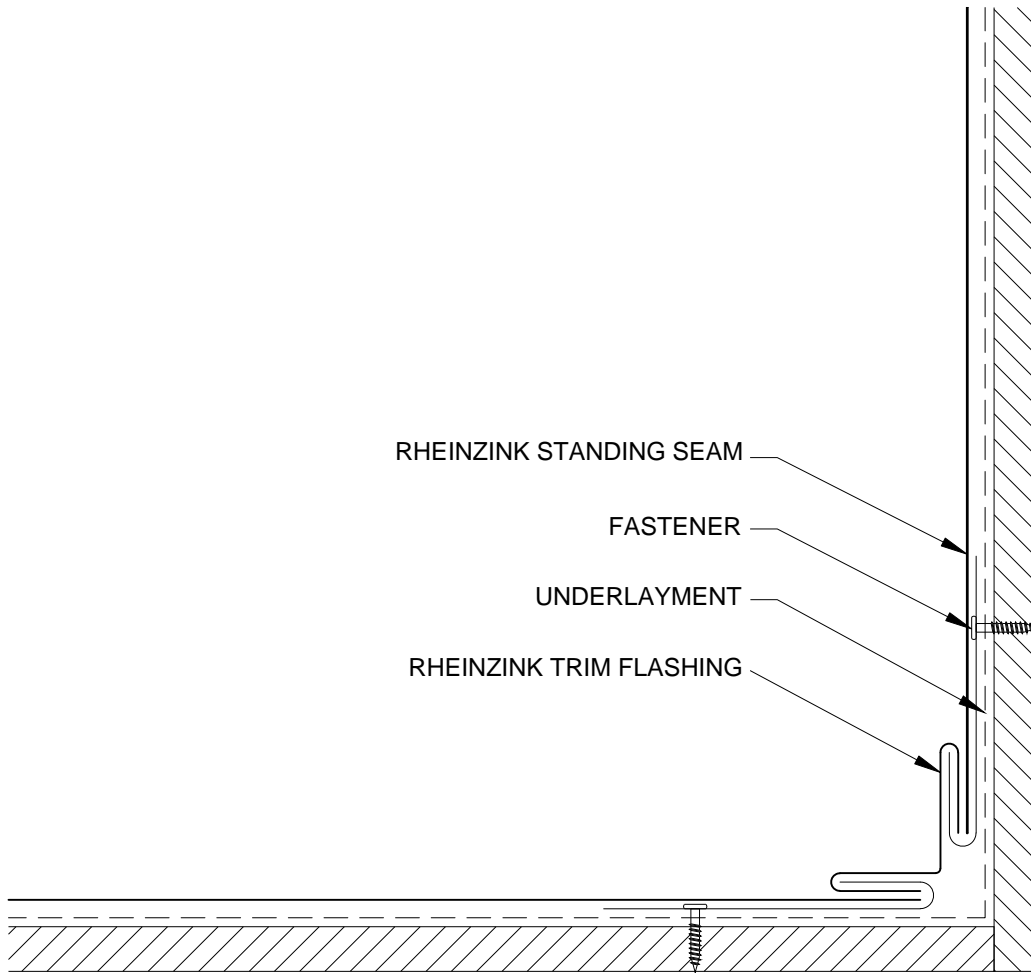

NOTES:

1. RHEINZINK RECOMMENDS STAINLESS STEEL FASTENERS AND CLIPS.
2. ZINC CLIPS MAY BE USED ON FACADES.



Website: www.rheinzink.us E-mail: info@rheinzink.com

INFORMATION AND DETAILS HEREIN ARE ONLY A BASELINE FOR SYSTEM DESIGN AND INSTALLATION. MODIFICATION TO MEET PROJECT REQUIREMENTS IS THE RESPONSIBILITY OF THE DESIGNER AND ARCHITECT. RHEINZINK AMERICA STAFF ARE AVAILABLE TO ASSIST THE DESIGNER AND ARCHITECT IN THIS PROCESS. RHEINZINK AMERICA MAKES NO REPRESENTATIONS AND WARRANTIES OTHER THAN THOSE EXPRESSED HEREIN.

PROJECT:	STAND. SEAM FACADE DETAILS - V	DATE:	08-2011
DRAWING TITLE:	INSIDE CORNER DETAIL - OPT. 1	SCALE:	N.T.S.
COPYRIGHT RESERVED. THIS DRAWING REMAINS THE PROPERTY OF RHEINZINK.		SHEET:	SSF-V-5a

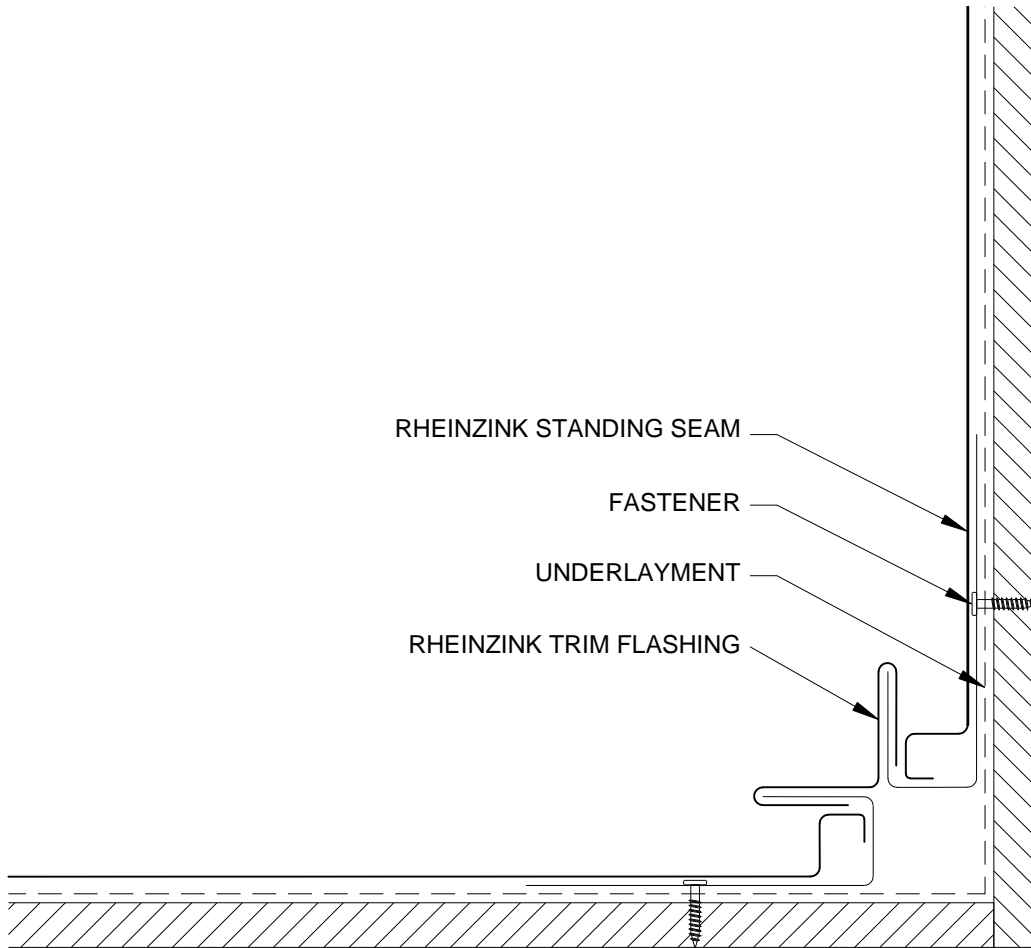

NOTES:

1. RHEINZINK RECOMMENDS STAINLESS STEEL FASTENERS AND CLIPS.
2. ZINC CLIPS MAY BE USED ON FACADES.



Website: www.rheinzink.us E-mail: info@rheinzink.com

INFORMATION AND DETAILS HEREIN ARE ONLY A BASELINE FOR SYSTEM DESIGN AND INSTALLATION. MODIFICATION TO MEET PROJECT REQUIREMENTS IS THE RESPONSIBILITY OF THE DESIGNER AND ARCHITECT. RHEINZINK AMERICA STAFF ARE AVAILABLE TO ASSIST THE DESIGNER AND ARCHITECT IN THIS PROCESS. RHEINZINK AMERICA MAKES NO REPRESENTATIONS AND WARRANTIES OTHER THAN THOSE EXPRESSED HEREIN.

PROJECT:	STAND. SEAM FACADE DETAILS - V	DATE:	08-2011
DRAWING TITLE:	INSIDE CORNER DETAIL - OPT. 2	SCALE:	N.T.S.
COPYRIGHT RESERVED. THIS DRAWING REMAINS THE PROPERTY OF RHEINZINK.		SHEET:	SSF-V-5b

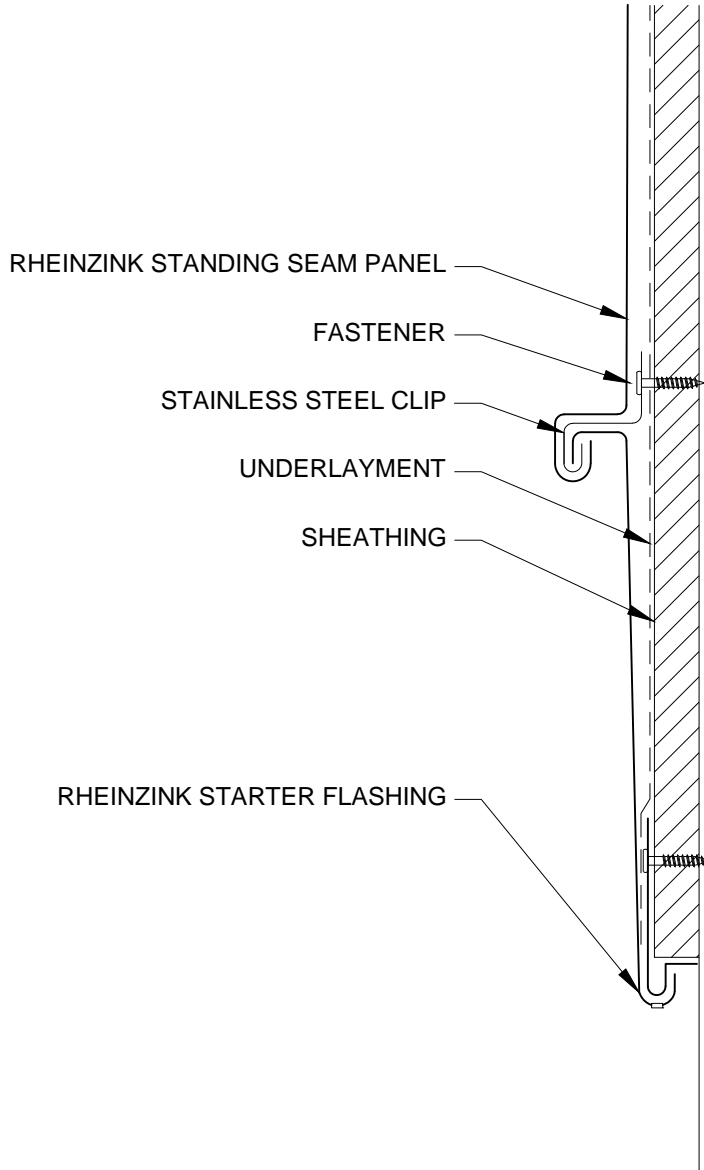

NOTES:

1. RHEINZINK RECOMMENDS STAINLESS STEEL FASTENERS AND CLIPS.
2. ZINC CLIPS MAY BE USED ON FACADES.



Website: www.rheinzink.us E-mail: info@rheinzink.com

INFORMATION AND DETAILS HEREIN ARE ONLY A BASELINE FOR SYSTEM DESIGN AND INSTALLATION. MODIFICATION TO MEET PROJECT REQUIREMENTS IS THE RESPONSIBILITY OF THE DESIGNER AND ARCHITECT. RHEINZINK AMERICA STAFF ARE AVAILABLE TO ASSIST THE DESIGNER AND ARCHITECT IN THIS PROCESS. RHEINZINK AMERICA MAKES NO REPRESENTATIONS AND WARRANTIES OTHER THAN THOSE EXPRESSED HEREIN.

PROJECT:	STAND. SEAM FACADE DETAILS - V	DATE:	12-2011
DRAWING TITLE:	BASE TERMINATION DETAIL - OPT. 1	SCALE:	N.T.S.
COPYRIGHT RESERVED. THIS DRAWING REMAINS THE PROPERTY OF RHEINZINK.		SHEET:	SSF-V-6a

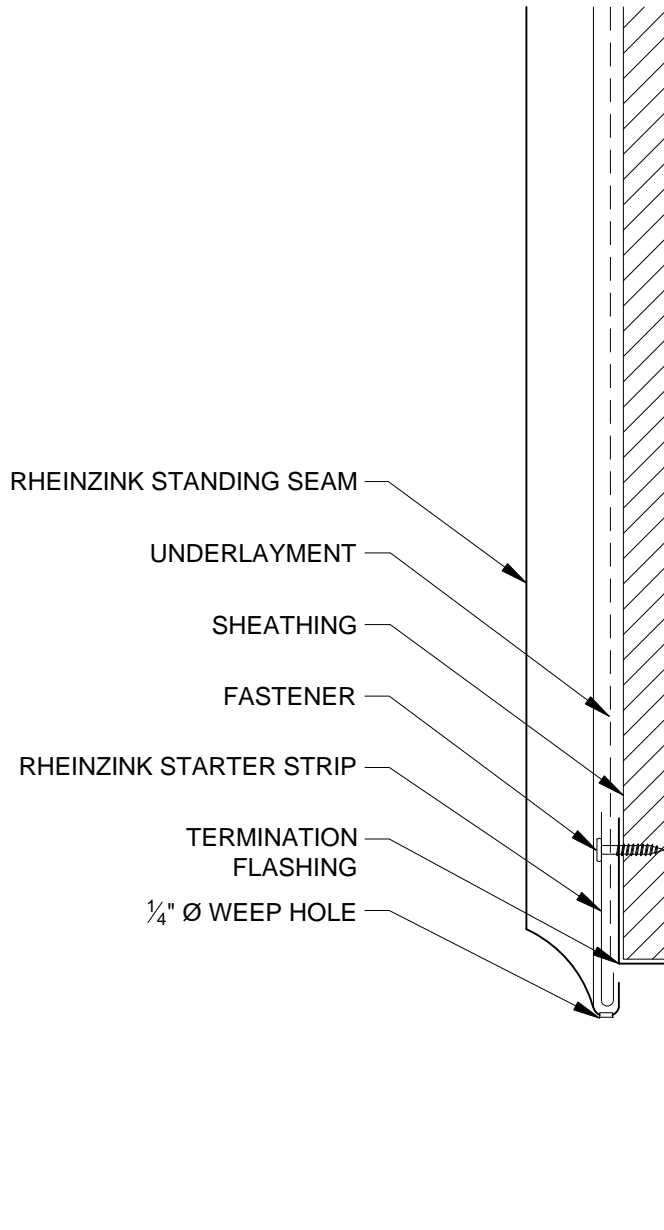

NOTES:

1. RHEINZINK RECOMMENDS STAINLESS STEEL FASTENERS AND CLIPS.
2. ZINC CLIPS MAY BE USED ON FACADES.



Website: www.rheinzink.us E-mail: info@rheinzink.com

INFORMATION AND DETAILS HEREIN ARE ONLY A BASELINE FOR SYSTEM DESIGN AND INSTALLATION. MODIFICATION TO MEET PROJECT REQUIREMENTS IS THE RESPONSIBILITY OF THE DESIGNER AND ARCHITECT. RHEINZINK AMERICA STAFF ARE AVAILABLE TO ASSIST THE DESIGNER AND ARCHITECT IN THIS PROCESS. RHEINZINK AMERICA MAKES NO REPRESENTATIONS AND WARRANTIES OTHER THAN THOSE EXPRESSED HEREIN.

PROJECT:	STAND. SEAM FACADE DETAILS - V	DATE:	08-2011
DRAWING TITLE:	BASE TERMINATION DETAIL - OPT. 2	SCALE:	N.T.S.
COPYRIGHT RESERVED. THIS DRAWING REMAINS THE PROPERTY OF RHEINZINK.		SHEET:	SSF-V-6b

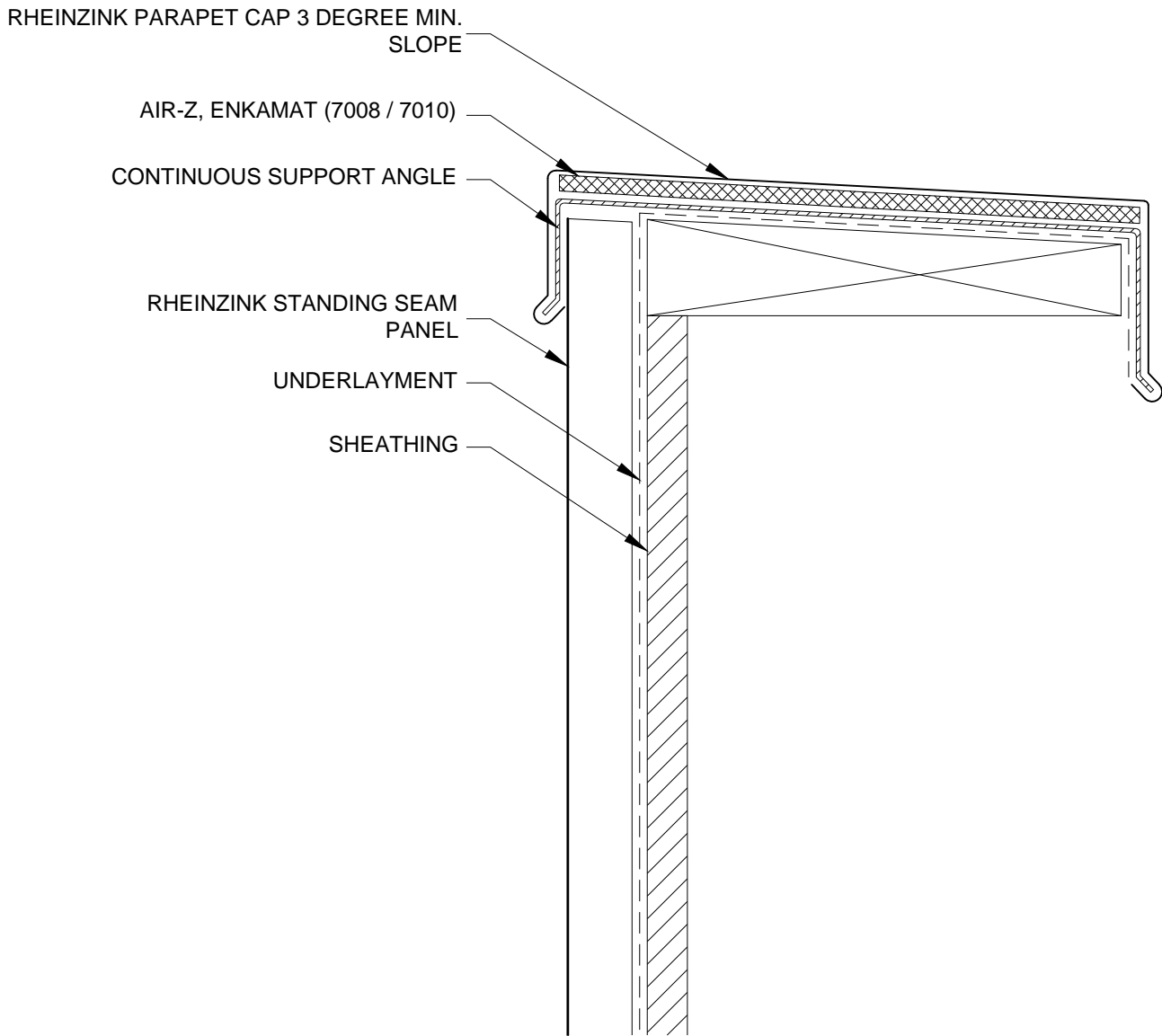

NOTES:

1. RHEINZINK RECOMMENDS STAINLESS STEEL FASTENERS AND CLIPS.
2. ZINC CLIPS MAY BE USED ON FACADES.



Website: www.rheinzink.us E-mail: info@rheinzink.com

INFORMATION AND DETAILS HEREIN ARE ONLY A BASELINE FOR SYSTEM DESIGN AND INSTALLATION. MODIFICATION TO MEET PROJECT REQUIREMENTS IS THE RESPONSIBILITY OF THE DESIGNER AND ARCHITECT. RHEINZINK AMERICA STAFF ARE AVAILABLE TO ASSIST THE DESIGNER AND ARCHITECT IN THIS PROCESS. RHEINZINK AMERICA MAKES NO REPRESENTATIONS AND WARRANTIES OTHER THAN THOSE EXPRESSED HEREIN.

PROJECT:	STAND. SEAM FACADE DETAILS - V	DATE:	08-2011
DRAWING TITLE:	PARAPET DETAIL - OPT. 1	SCALE:	N.T.S.
COPYRIGHT RESERVED. THIS DRAWING REMAINS THE PROPERTY OF RHEINZINK.		SHEET:	SSF-V-7a

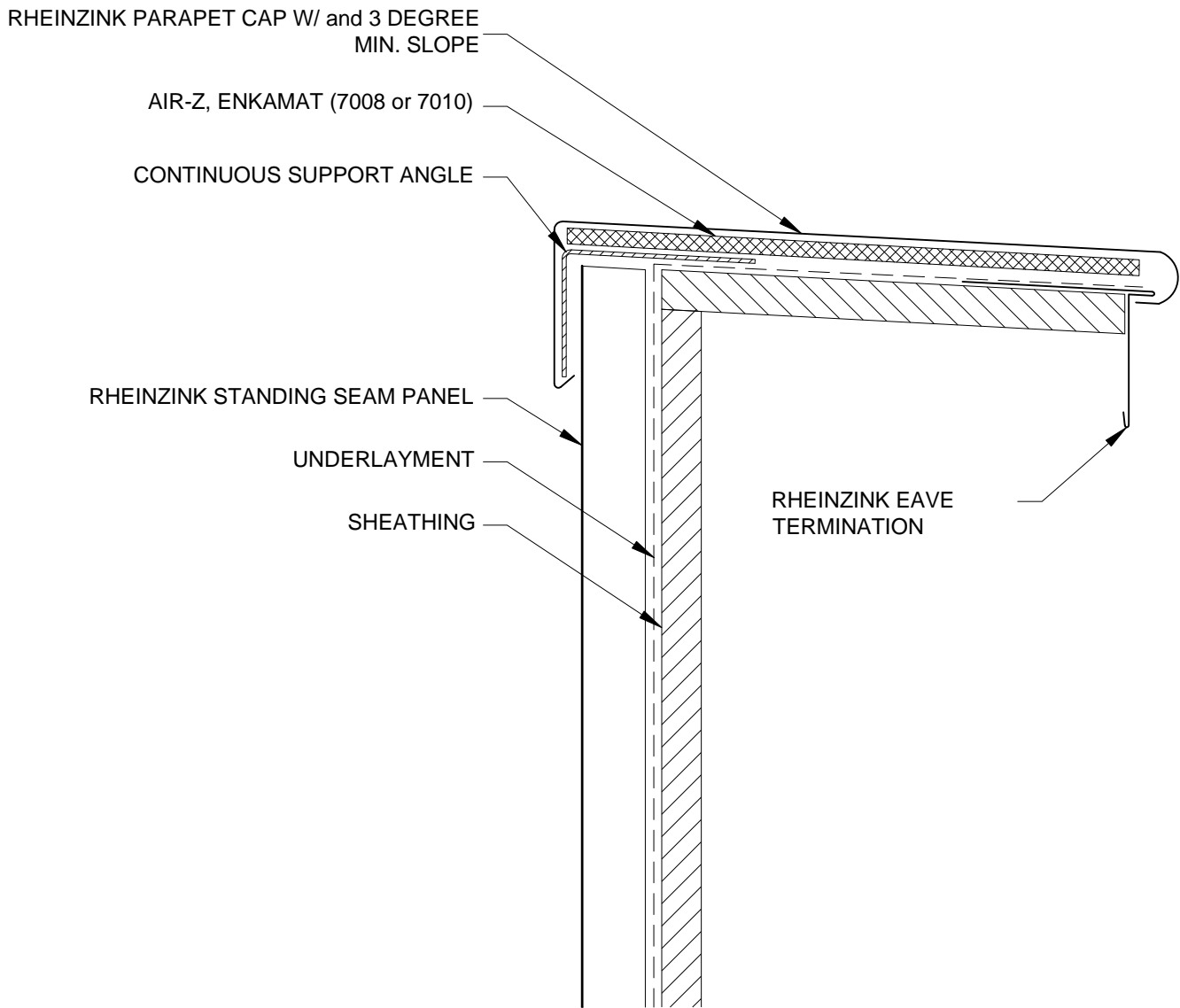

NOTES:

1. RHEINZINK RECOMMENDS STAINLESS STEEL FASTENERS AND CLIPS.
2. ZINC CLIPS MAY BE USED ON FACADES.

 Website: www.rheinzink.us E-mail: info@rheinzink.com	
INFORMATION AND DETAILS HEREIN ARE ONLY A BASELINE FOR SYSTEM DESIGN AND INSTALLATION. MODIFICATION TO MEET PROJECT REQUIREMENTS IS THE RESPONSIBILITY OF THE DESIGNER AND ARCHITECT. RHEINZINK AMERICA STAFF ARE AVAILABLE TO ASSIST THE DESIGNER AND ARCHITECT IN THIS PROCESS. RHEINZINK AMERICA MAKES NO REPRESENTATIONS AND WARRANTIES OTHER THAN THOSE EXPRESSED HEREIN.	
PROJECT: STAND. SEAM FACADE DETAILS - V	DATE: 12-2011
DRAWING TITLE: PARAPET DETAIL - OPT. 2	SCALE: N.T.S.
COPYRIGHT RESERVED. THIS DRAWING REMAINS THE PROPERTY OF RHEINZINK.	SHEET: SSF-V-7b

STANDING SEAM PANEL ROLLOVER DETAIL W/
3 DEGREE MIN. SLOPE

IR-Z, ENKAMAT (7008 / 7010) STAINLESS

STEEL CLIP

RHEINZINK STANDING SEAM PANEL

UNDERLAYMENT

SHEATHING

RHEINZINK EDGE
DETAIL

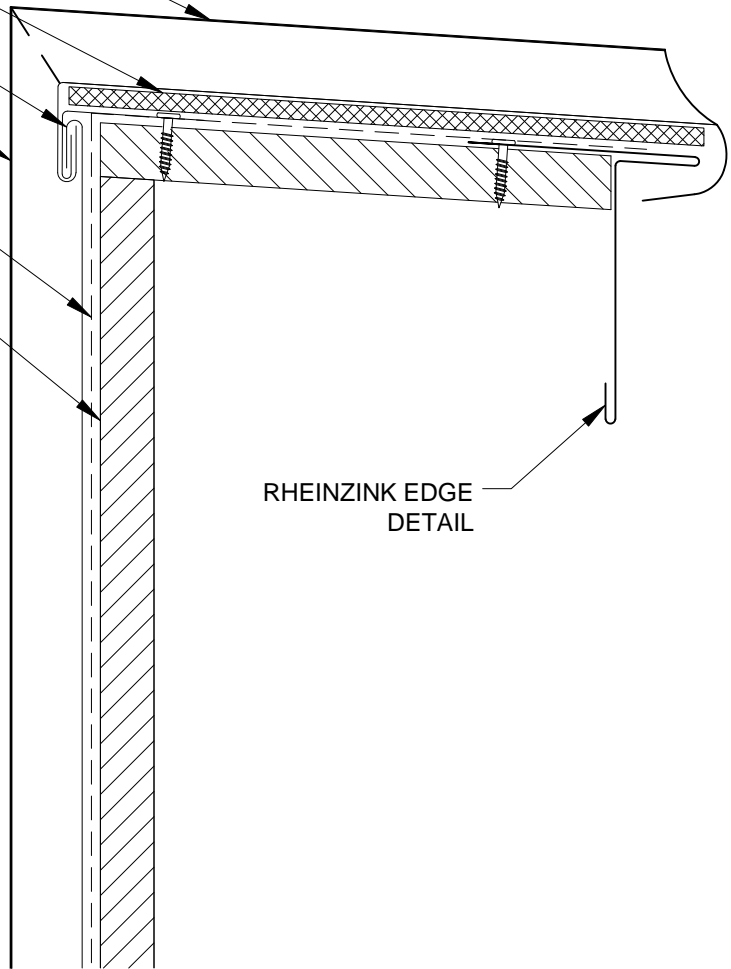

NOTES:

1. RHEINZINK RECOMMENDS STAINLESS STEEL FASTENERS AND CLIPS.
2. ZINC CLIPS MAY BE USED ON FACADES.



Website: www.rheinzink.us E-mail: info@rheinzink.com

INFORMATION AND DETAILS HEREIN ARE ONLY A BASELINE FOR SYSTEM DESIGN AND INSTALLATION. MODIFICATION TO MEET PROJECT REQUIREMENTS IS THE RESPONSIBILITY OF THE DESIGNER AND ARCHITECT. RHEINZINK AMERICA STAFF ARE AVAILABLE TO ASSIST THE DESIGNER AND ARCHITECT IN THIS PROCESS. RHEINZINK AMERICA MAKES NO REPRESENTATIONS AND WARRANTIES OTHER THAN THOSE EXPRESSED HEREIN.

PROJECT:	STAND. SEAM FACADE DETAILS - V	DATE:	10-2011
DRAWING TITLE:	PARAPET DETAIL - OPT. 3	SCALE:	N.T.S.
COPYRIGHT RESERVED. THIS DRAWING REMAINS THE PROPERTY OF RHEINZINK.		SHEET:	SSF-V-7c

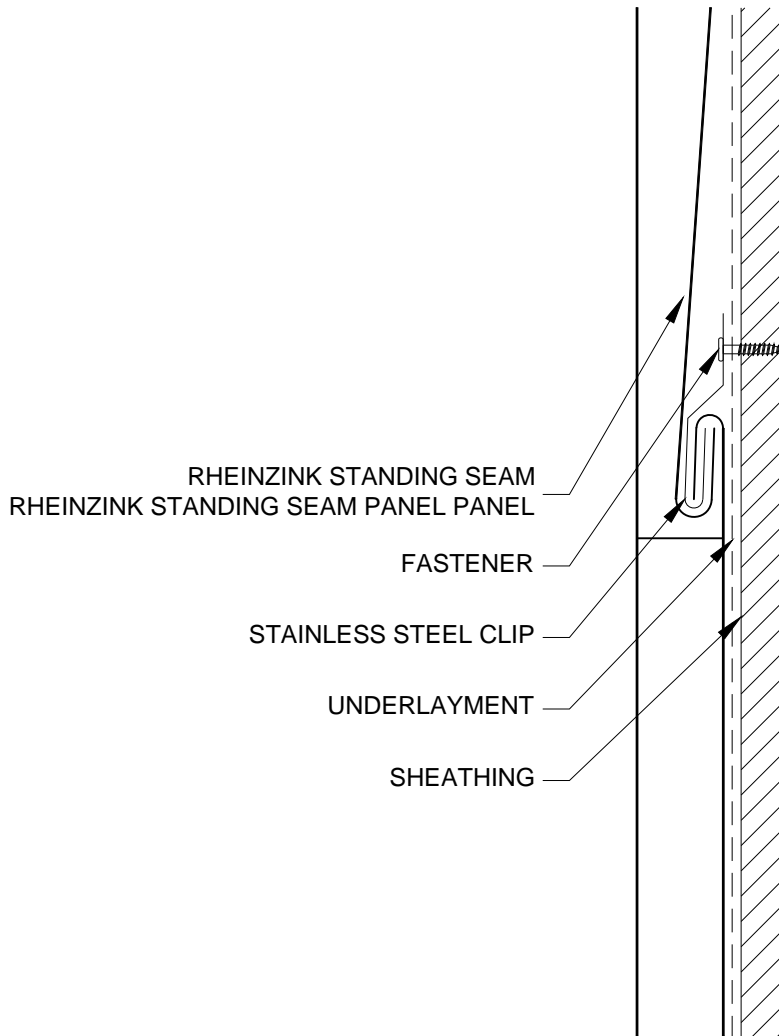

NOTES:

1. RHEINZINK RECOMMENDS STAINLESS STEEL FASTENERS AND CLIPS.
2. ZINC CLIPS MAY BE USED ON FACADES.



Website: www.rheinzink.us E-mail: info@rheinzink.com

INFORMATION AND DETAILS HEREIN ARE ONLY A BASELINE FOR SYSTEM DESIGN AND INSTALLATION. MODIFICATION TO MEET PROJECT REQUIREMENTS IS THE RESPONSIBILITY OF THE DESIGNER AND ARCHITECT. RHEINZINK AMERICA STAFF ARE AVAILABLE TO ASSIST THE DESIGNER AND ARCHITECT IN THIS PROCESS. RHEINZINK AMERICA MAKES NO REPRESENTATIONS AND WARRANTIES OTHER THAN THOSE EXPRESSED HEREIN.

PROJECT:	STAND. SEAM FACADE DETAILS - V	DATE:	10-2011
DRAWING TITLE:	HORIZONTAL SEAM DETAIL	SCALE:	N.T.S.
COPYRIGHT RESERVED. THIS DRAWING REMAINS THE PROPERTY OF RHEINZINK.		SHEET:	SSF-V-8

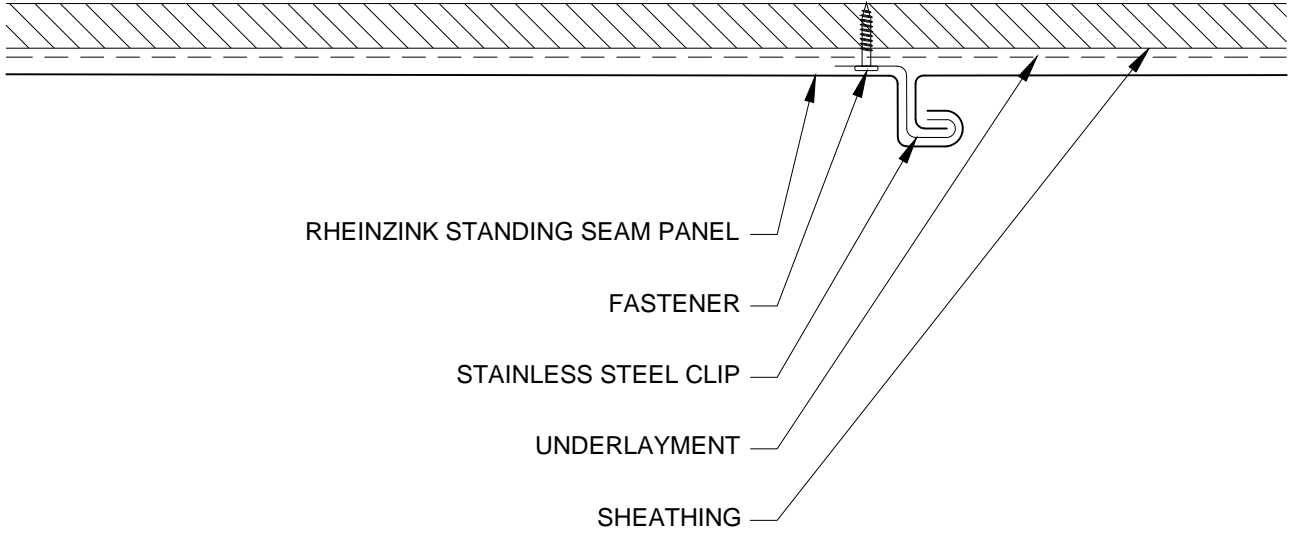

NOTES:

1. RHEINZINK RECOMMENDS STAINLESS STEEL FASTENERS AND CLIPS.
2. ZINC CLIPS MAY BE USED ON FACADES.

 Website: www.rheinzink.us E-mail: info@rheinzink.com	
INFORMATION AND DETAILS HEREIN ARE ONLY A BASELINE FOR SYSTEM DESIGN AND INSTALLATION. MODIFICATION TO MEET PROJECT REQUIREMENTS IS THE RESPONSIBILITY OF THE DESIGNER AND ARCHITECT. RHEINZINK AMERICA STAFF ARE AVAILABLE TO ASSIST THE DESIGNER AND ARCHITECT IN THIS PROCESS. RHEINZINK AMERICA MAKES NO REPRESENTATIONS AND WARRANTIES OTHER THAN THOSE EXPRESSED HEREIN.	
PROJECT: STAND. SEAM FACADE DETAILS - V	DATE: 08-2011
DRAWING TITLE: VERTICAL SEAM DETAIL	SCALE: N.T.S.
COPYRIGHT RESERVED. THIS DRAWING REMAINS THE PROPERTY OF RHEINZINK.	SHEET: SSF-V-9

GENERAL NOTES:

1. ALL DIMENSIONS ARE INCHES OR FRACTIONS THEREOF.
2. MATERIAL .7mm OR .8mm RHEINZINK PREWEATHERED TITANIUM ZINC.

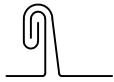
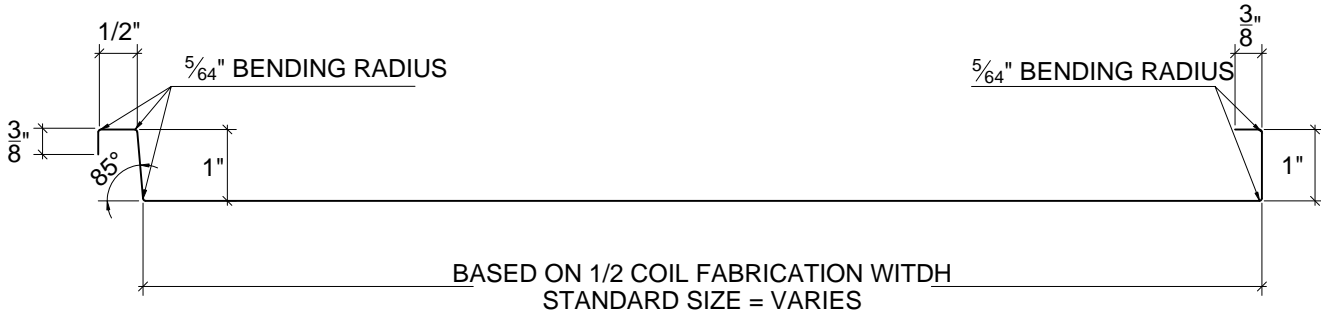

DOUBLE LOCK
STANDING
SEAM
SLOPE

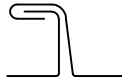

ANGLED
STANDING
SEAM

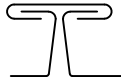

DOUBLE ANGLED

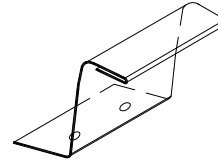

FIXED CLIP

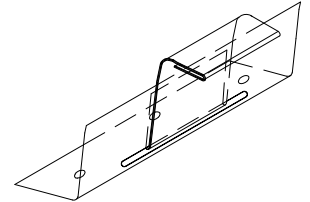

SLIDING CLIP

NOTES:

1. RHEINZINK RECOMMENDS STAINLESS STEEL FASTENERS AND CLIPS.
2. ZINC CLIPS MAY BE USED ON FACADES.



Website: www.rheinzink.us E-mail: info@rheinzink.com

INFORMATION AND DETAILS HEREIN ARE ONLY A BASELINE FOR SYSTEM DESIGN AND INSTALLATION. MODIFICATION TO MEET PROJECT REQUIREMENTS IS THE RESPONSIBILITY OF THE DESIGNER AND ARCHITECT. RHEINZINK AMERICA STAFF ARE AVAILABLE TO ASSIST THE DESIGNER AND ARCHITECT IN THIS PROCESS. RHEINZINK AMERICA MAKES NO REPRESENTATIONS AND WARRANTIES OTHER THAN THOSE EXPRESSED HEREIN.

PROJECT:	STAND. SEAM FACADE DETAILS - V	DATE:	08-2011
DRAWING TITLE:	PANEL & SEAM PROFILE	SCALE:	N.T.S.
COPYRIGHT RESERVED. THIS DRAWING REMAINS THE PROPERTY OF RHEINZINK.		SHEET:	SSF-V-10