



RHEINZINK America, Inc.

TRAPEZOIDAL FACADE - VERTICAL

INDEX OF DRAWINGS

- TF-V-1 - HEAD DETAIL
- TF-V-2 - JAMB DETAIL
- TF-V-3 - SILL DETAIL
- TF-V-4 - OUTSIDE CORNER DETAIL
- TF-V-5 - INSIDE CORNER DETAIL
- TF-V-6 - BASE TERMINATION DETAIL
- TF-V-7 - PARAPET DETAIL
- TF-V-8 - HORIZONTAL SEAM DETAIL
- TF-V-9 - VERTICAL SEAM DETAIL
- TF-V-10 - PANEL PROFILE DETAIL

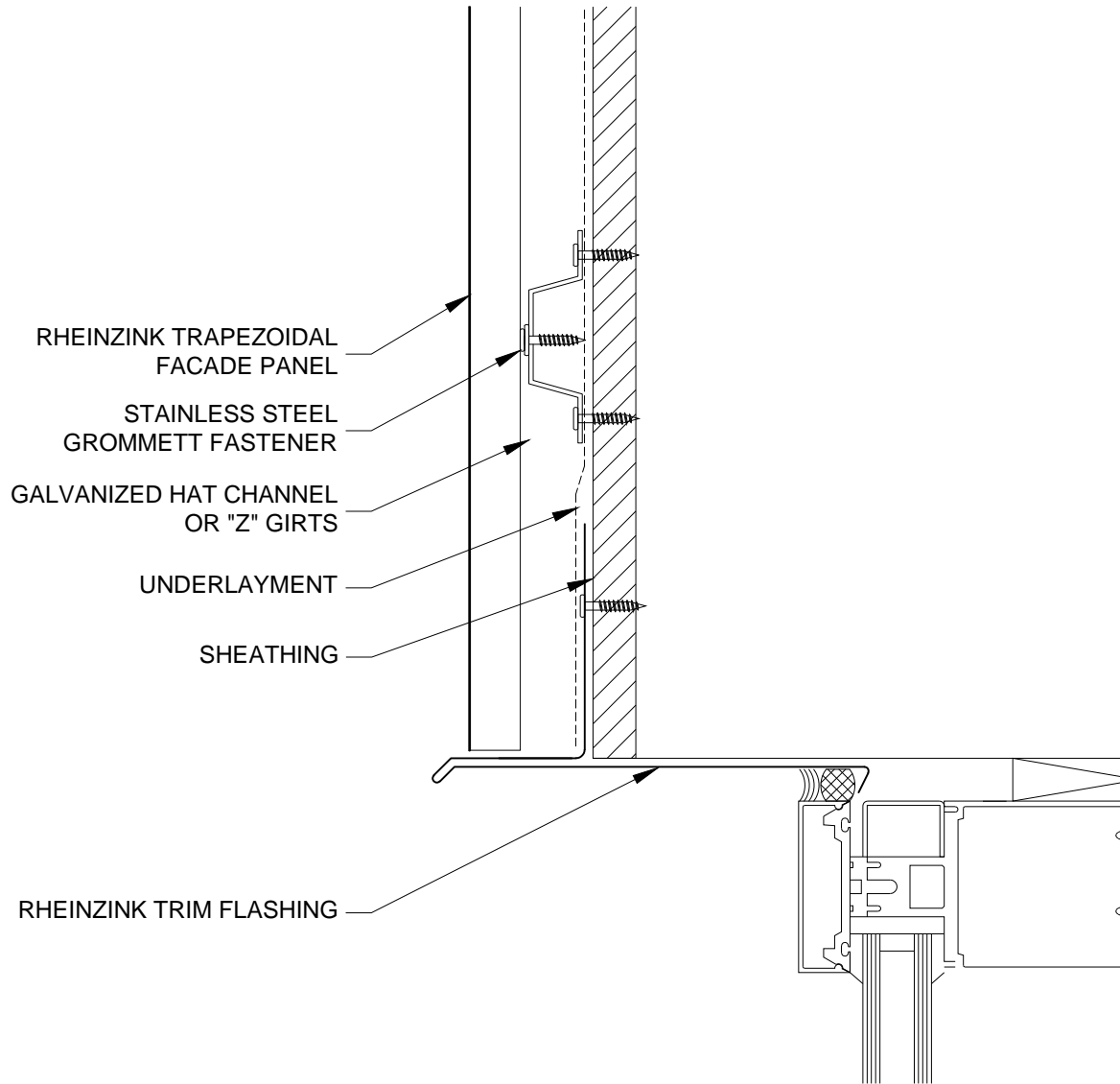

Website: www.rheinzink.com E-mail: info@rheinzink.com

INFORMATION AND DETAILS HEREIN ARE ONLY A BASELINE FOR SYSTEM DESIGN AND INSTALLATION. MODIFICATION TO MEET PROJECT REQUIREMENTS IS THE RESPONSIBILITY OF THE DESIGNER AND ARCHITECT. RHEINZINK AMERICA STAFF ARE AVAILABLE TO ASSIST THE DESIGNER AND ARCHITECT IN THIS PROCESS. RHEINZINK AMERICA MAKES NO REPRESENTATIONS AND WARRANTIES OTHER THAN THOSE EXPRESSED HEREIN.

PROJECT:	TRAPEZOIDAL FACADE - V	DATE:	08-2011
DRAWING TITLE:	HEAD DETAIL	SCALE:	N.T.S.
COPYRIGHT RESERVED. THIS DRAWING REMAINS THE PROPERTY OF RHEINZINK.		SHEET:	TF-V-1

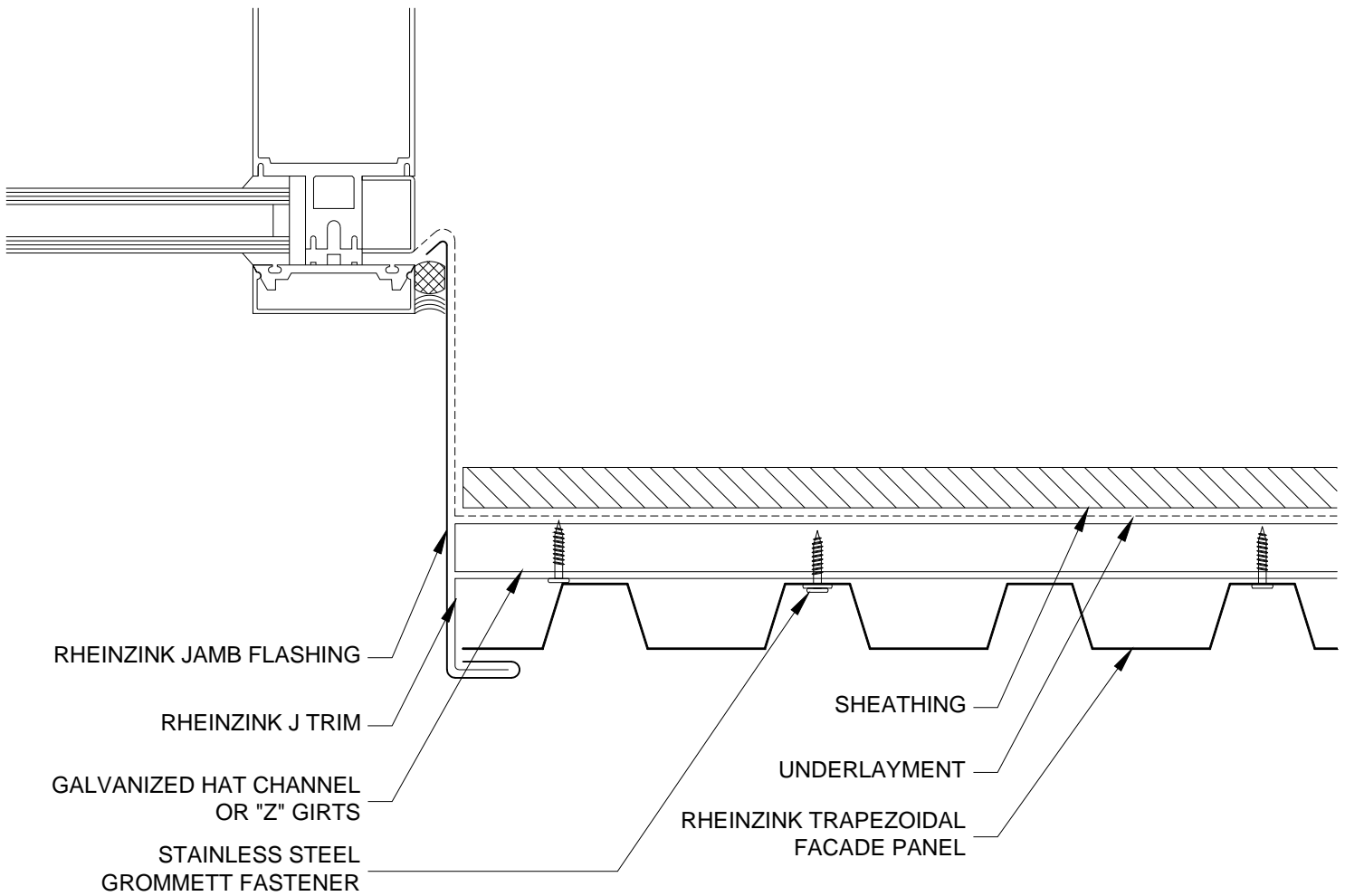

Website: www.rheinzink.com E-mail: info@rheinzink.com

INFORMATION AND DETAILS HEREIN ARE ONLY A BASELINE FOR SYSTEM DESIGN AND INSTALLATION. MODIFICATION TO MEET PROJECT REQUIREMENTS IS THE RESPONSIBILITY OF THE DESIGNER AND ARCHITECT. RHEINZINK AMERICA STAFF ARE AVAILABLE TO ASSIST THE DESIGNER AND ARCHITECT IN THIS PROCESS. RHEINZINK AMERICA MAKES NO REPRESENTATIONS AND WARRANTIES OTHER THAN THOSE EXPRESSED HEREIN.

PROJECT:	TRAPEZOIDAL FACADE - V	DATE:	08-2011
----------	------------------------	-------	---------

DRAWING TITLE:	JAMB DETAIL	SCALE:	N.T.S.
----------------	-------------	--------	--------

COPYRIGHT RESERVED. THIS DRAWING REMAINS THE PROPERTY OF RHEINZINK.	SHEET:	TF-V-2
---	--------	--------

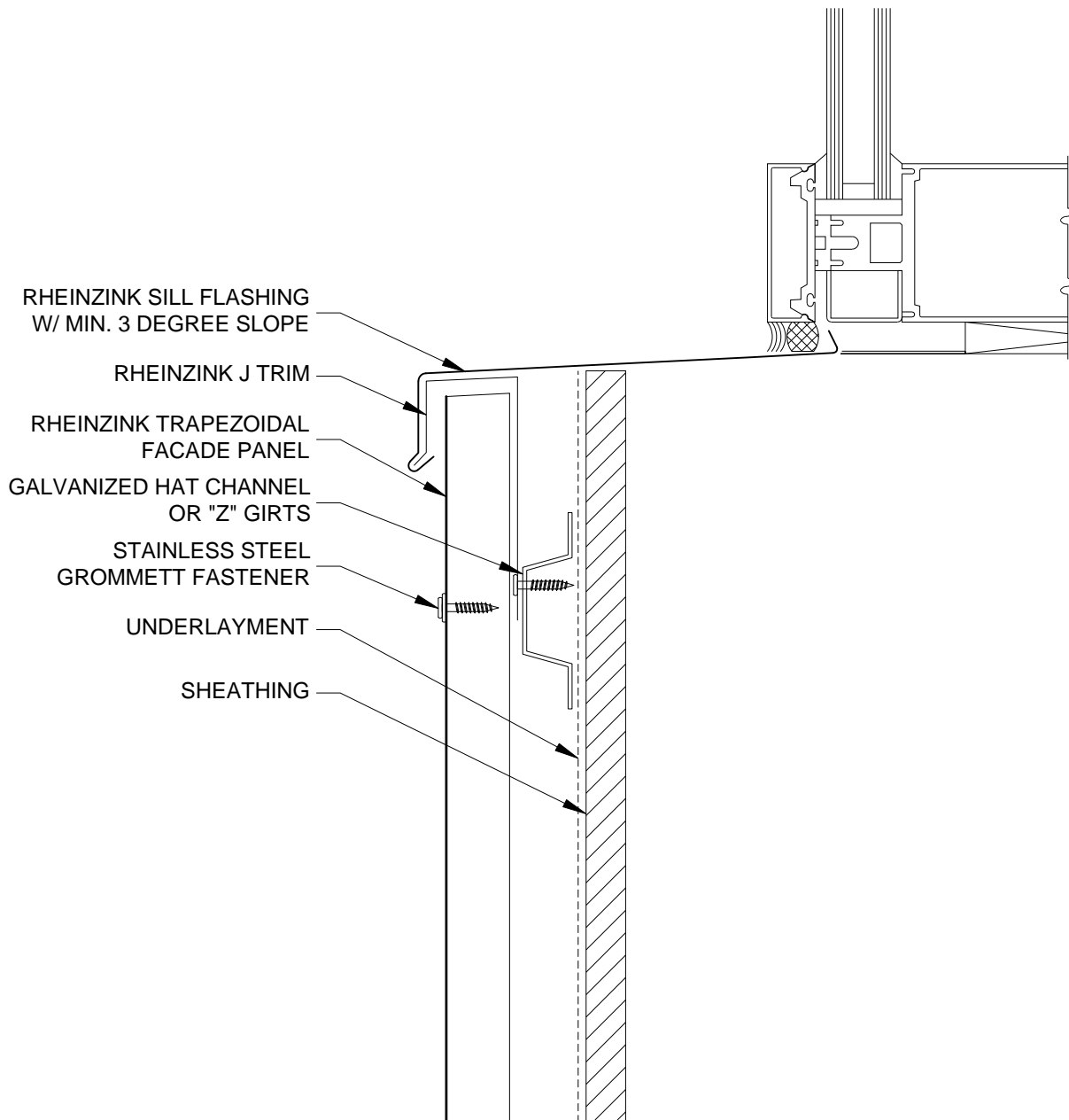

Website: www.rheinzink.com E-mail: info@rheinzink.com

INFORMATION AND DETAILS HEREIN ARE ONLY A BASELINE FOR SYSTEM DESIGN AND INSTALLATION. MODIFICATION TO MEET PROJECT REQUIREMENTS IS THE RESPONSIBILITY OF THE DESIGNER AND ARCHITECT. RHEINZINK AMERICA STAFF ARE AVAILABLE TO ASSIST THE DESIGNER AND ARCHITECT IN THIS PROCESS. RHEINZINK AMERICA MAKES NO REPRESENTATIONS AND WARRANTIES OTHER THAN THOSE EXPRESSED HEREIN.

PROJECT:	TRAPEZOIDAL FACADE - V	DATE:	10-2011
DRAWING TITLE:	SILL DETAIL	SCALE:	N.T.S.
COPYRIGHT RESERVED. THIS DRAWING REMAINS THE PROPERTY OF RHEINZINK.		SHEET:	TF-V-3

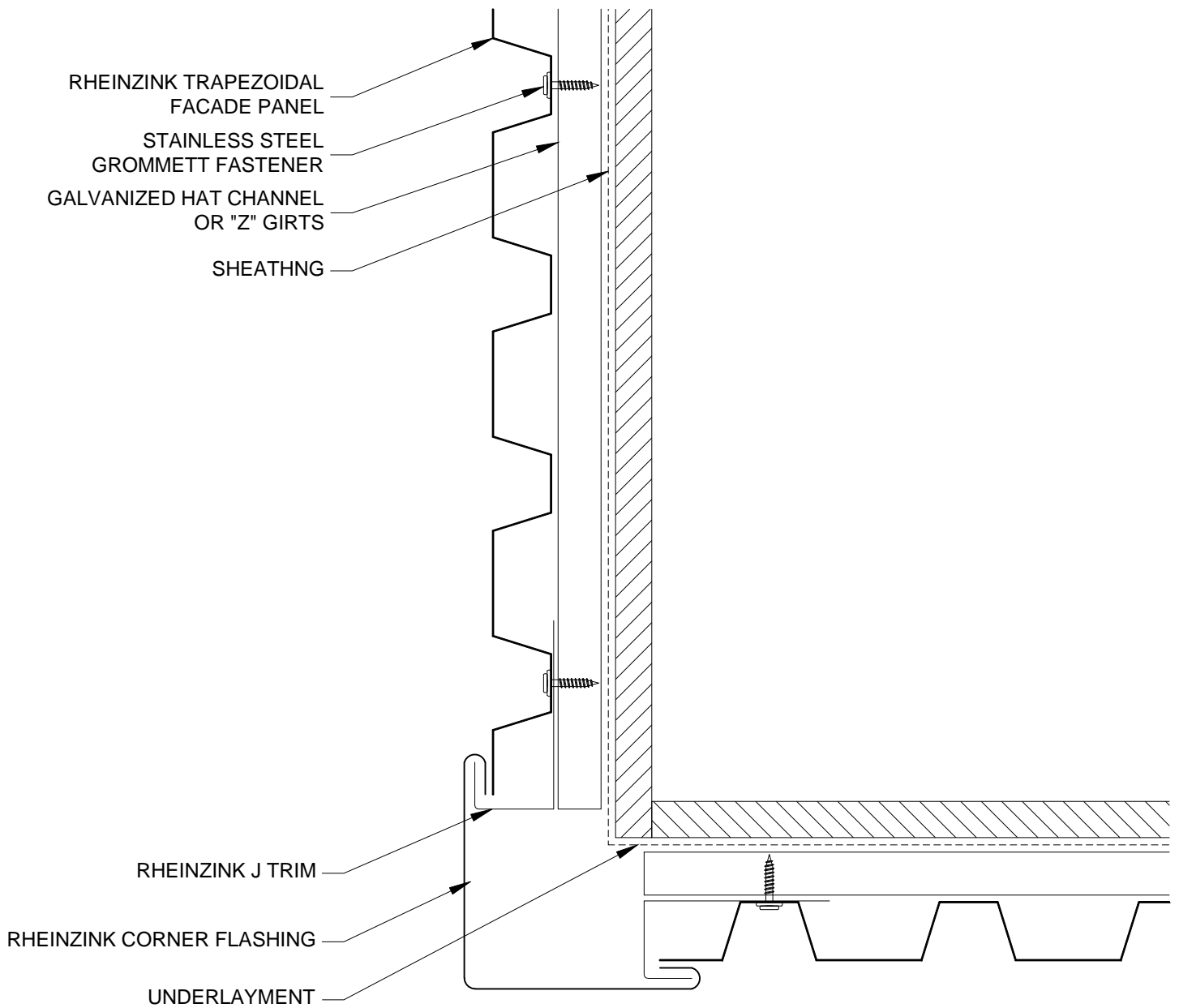

Website: www.rheinzink.com E-mail: info@rheinzink.com

INFORMATION AND DETAILS HEREIN ARE ONLY A BASELINE FOR SYSTEM DESIGN AND INSTALLATION. MODIFICATION TO MEET PROJECT REQUIREMENTS IS THE RESPONSIBILITY OF THE DESIGNER AND ARCHITECT. RHEINZINK AMERICA STAFF ARE AVAILABLE TO ASSIST THE DESIGNER AND ARCHITECT IN THIS PROCESS. RHEINZINK AMERICA MAKES NO REPRESENTATIONS AND WARRANTIES OTHER THAN THOSE EXPRESSED HEREIN.

PROJECT:	TRAPEZOIDAL FACADE - V	DATE:	08-2011
DRAWING TITLE:	OUTSIDE CORNER DETAIL	SCALE:	N.T.S.
COPYRIGHT RESERVED. THIS DRAWING REMAINS THE PROPERTY OF RHEINZINK.		SHEET:	TF-V-4

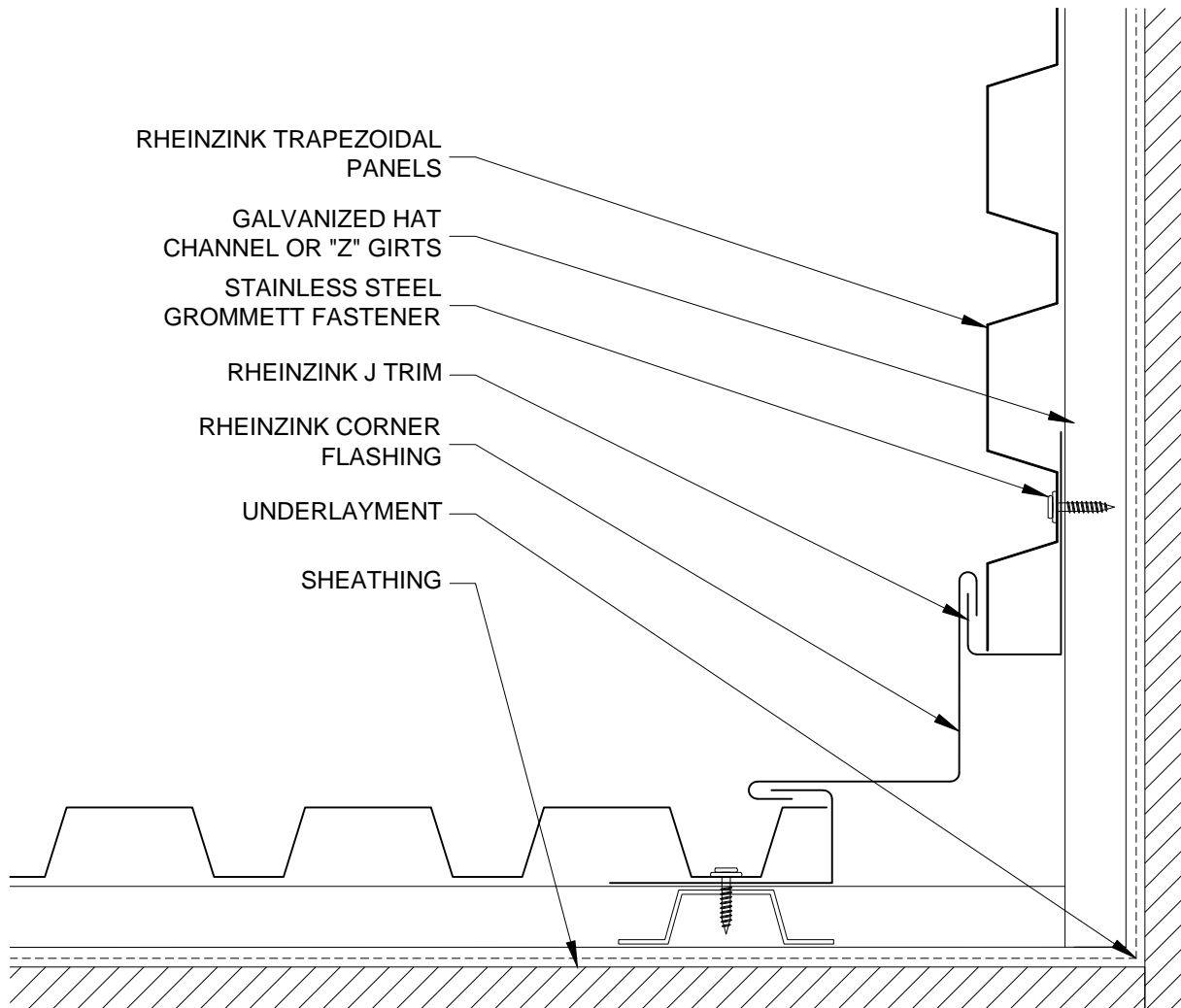

Website: www.rheinzink.com E-mail: info@rheinzink.com

INFORMATION AND DETAILS HEREIN ARE ONLY A BASELINE FOR SYSTEM DESIGN AND INSTALLATION. MODIFICATION TO MEET PROJECT REQUIREMENTS IS THE RESPONSIBILITY OF THE DESIGNER AND ARCHITECT. RHEINZINK AMERICA STAFF ARE AVAILABLE TO ASSIST THE DESIGNER AND ARCHITECT IN THIS PROCESS. RHEINZINK AMERICA MAKES NO REPRESENTATIONS AND WARRANTIES OTHER THAN THOSE EXPRESSED HEREIN.

PROJECT:	TRAPEZOIDAL FACADE - V	DATE:	08-2011
----------	------------------------	-------	---------

DRAWING TITLE:	INSIDE CORNER DETAIL	SCALE:	N.T.S.
----------------	----------------------	--------	--------

COPYRIGHT RESERVED. THIS DRAWING REMAINS THE PROPERTY OF RHEINZINK.	SHEET:	TF-V-5
---	--------	--------

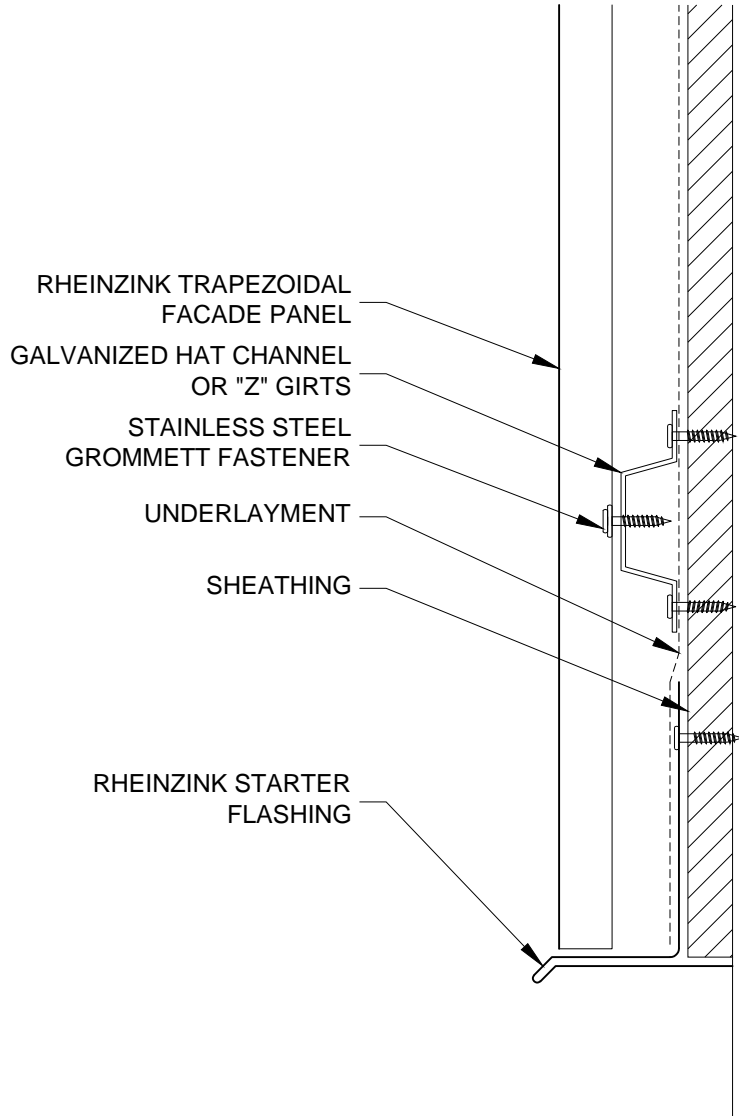

Website: www.rheinzink.com E-mail: info@rheinzink.com

INFORMATION AND DETAILS HEREIN ARE ONLY A BASELINE FOR SYSTEM DESIGN AND INSTALLATION. MODIFICATION TO MEET PROJECT REQUIREMENTS IS THE RESPONSIBILITY OF THE DESIGNER AND ARCHITECT. RHEINZINK AMERICA STAFF ARE AVAILABLE TO ASSIST THE DESIGNER AND ARCHITECT IN THIS PROCESS. RHEINZINK AMERICA MAKES NO REPRESENTATIONS AND WARRANTIES OTHER THAN THOSE EXPRESSED HEREIN.

PROJECT:	TRAPEZOIDAL FACADE - V	DATE:	03-2012
DRAWING TITLE:	BASE TERMINATION DETAIL	SCALE:	N.T.S.
COPYRIGHT RESERVED. THIS DRAWING REMAINS THE PROPERTY OF RHEINZINK.		SHEET:	TF-V-6

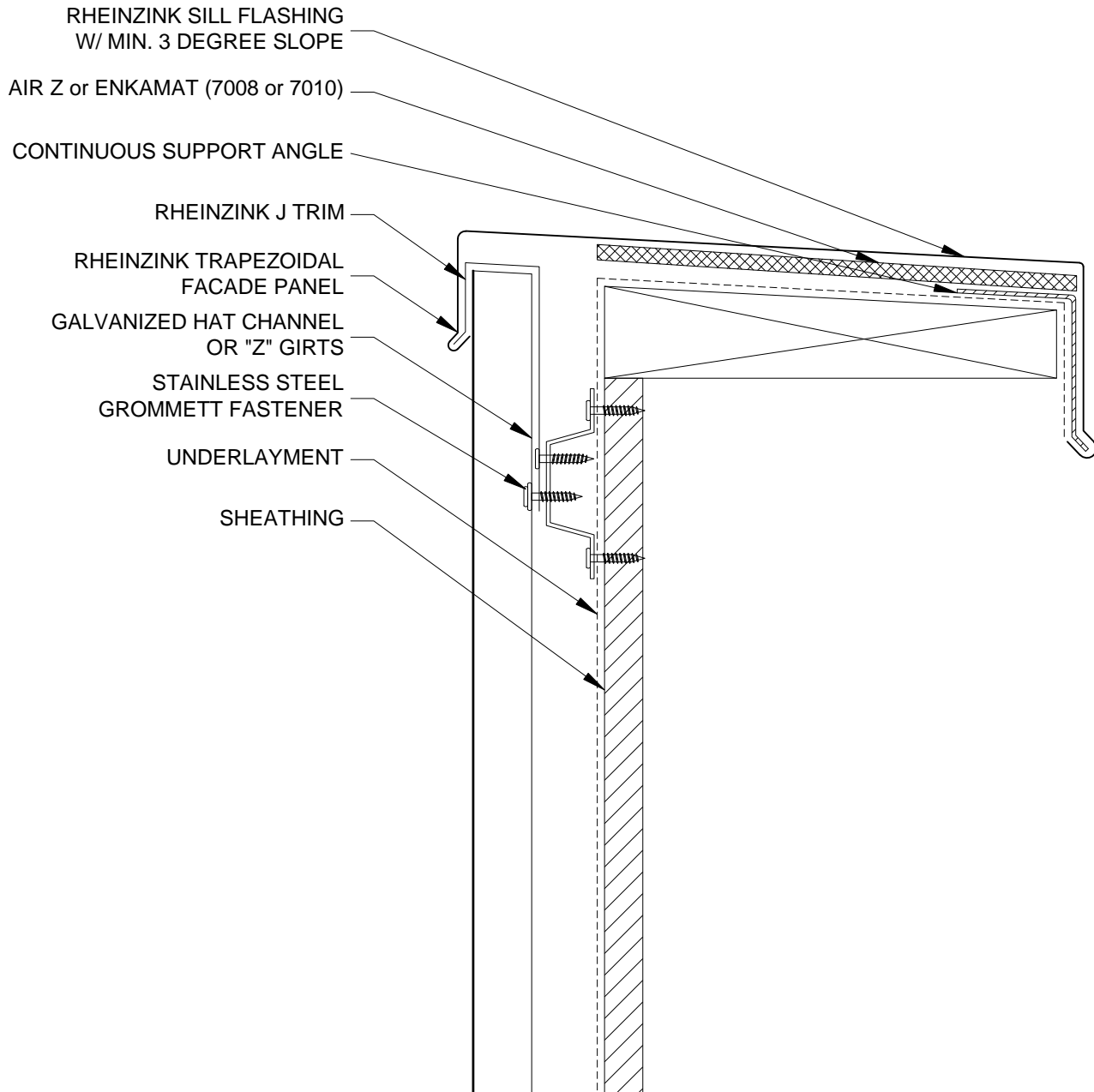

Website: www.rheinzink.com E-mail: info@rheinzink.com

INFORMATION AND DETAILS HEREIN ARE ONLY A BASELINE FOR SYSTEM DESIGN AND INSTALLATION. MODIFICATION TO MEET PROJECT REQUIREMENTS IS THE RESPONSIBILITY OF THE DESIGNER AND ARCHITECT. RHEINZINK AMERICA STAFF ARE AVAILABLE TO ASSIST THE DESIGNER AND ARCHITECT IN THIS PROCESS. RHEINZINK AMERICA MAKES NO REPRESENTATIONS AND WARRANTIES OTHER THAN THOSE EXPRESSED HEREIN.

PROJECT:	TRAPEZOIDAL FACADE - V	DATE:	10-2011
----------	------------------------	-------	---------

DRAWING TITLE:	PARAPET DETAIL	SCALE:	N.T.S.
----------------	----------------	--------	--------

COPYRIGHT RESERVED. THIS DRAWING REMAINS THE PROPERTY OF RHEINZINK.	SHEET:	TF-V-7
---	--------	--------

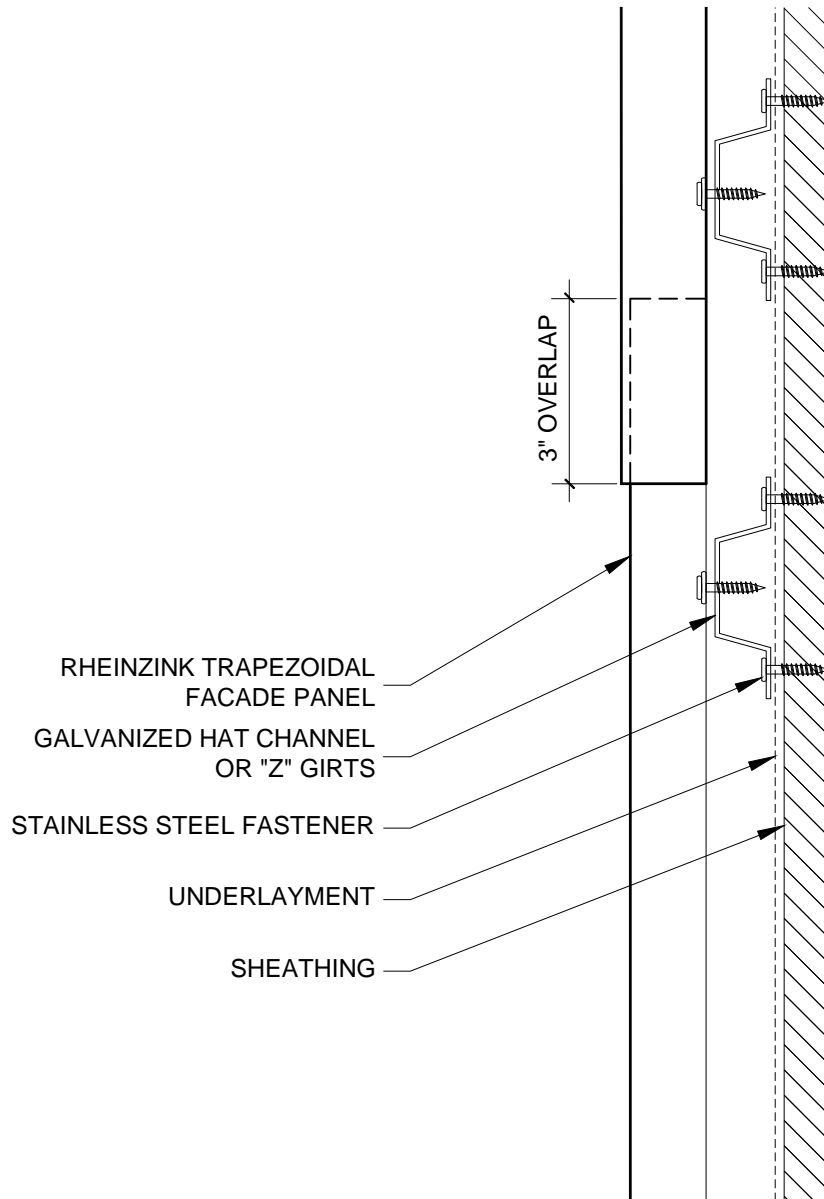

Website: www.rheinzink.com E-mail: info@rheinzink.com

INFORMATION AND DETAILS HEREIN ARE ONLY A BASELINE FOR SYSTEM DESIGN AND INSTALLATION. MODIFICATION TO MEET PROJECT REQUIREMENTS IS THE RESPONSIBILITY OF THE DESIGNER AND ARCHITECT. RHEINZINK AMERICA STAFF ARE AVAILABLE TO ASSIST THE DESIGNER AND ARCHITECT IN THIS PROCESS. RHEINZINK AMERICA MAKES NO REPRESENTATIONS AND WARRANTIES OTHER THAN THOSE EXPRESSED HEREIN.

PROJECT:	TRAPEZOIDAL FACADE - V	DATE:	03-2012
----------	------------------------	-------	---------

DRAWING TITLE:	HORIZONTAL SEAM DETAIL	SCALE:	N.T.S.
----------------	------------------------	--------	--------

COPYRIGHT RESERVED. THIS DRAWING REMAINS THE PROPERTY OF RHEINZINK.	SHEET:	TF-V-8
---	--------	--------

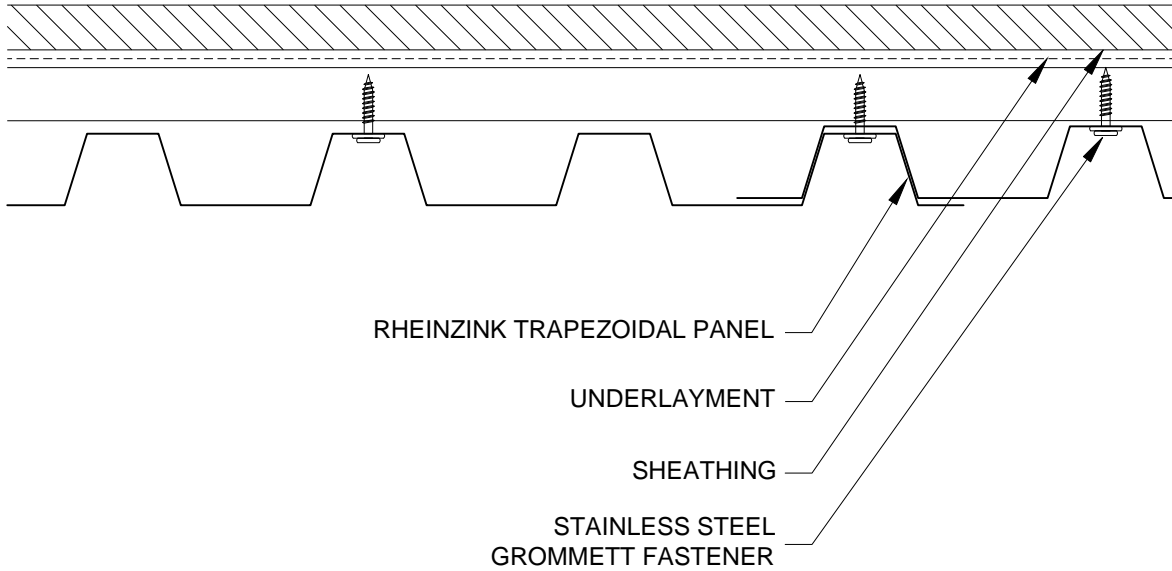

Website: www.rheinzink.com E-mail: info@rheinzink.com

INFORMATION AND DETAILS HEREIN ARE ONLY A BASELINE FOR SYSTEM DESIGN AND INSTALLATION. MODIFICATION TO MEET PROJECT REQUIREMENTS IS THE RESPONSIBILITY OF THE DESIGNER AND ARCHITECT. RHEINZINK AMERICA STAFF ARE AVAILABLE TO ASSIST THE DESIGNER AND ARCHITECT IN THIS PROCESS. RHEINZINK AMERICA MAKES NO REPRESENTATIONS AND WARRANTIES OTHER THAN THOSE EXPRESSED HEREIN.

PROJECT:	TRAPEZOIDAL FACADE - V	DATE:	08-2011
DRAWING TITLE:	VERTICAL SEAM DETAIL	SCALE:	N.T.S.
COPYRIGHT RESERVED. THIS DRAWING REMAINS THE PROPERTY OF RHEINZINK.		SHEET:	TF-V-9

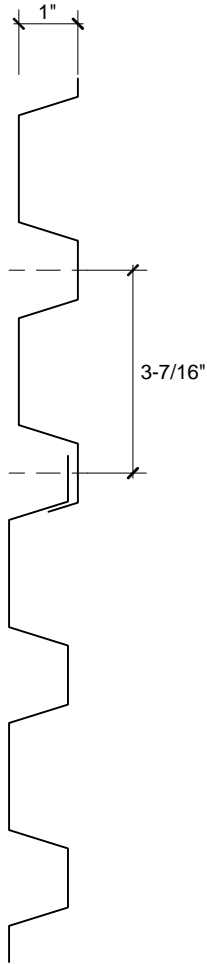

$8 \times 3\text{-}7/16" = 27\text{-}9/16"$

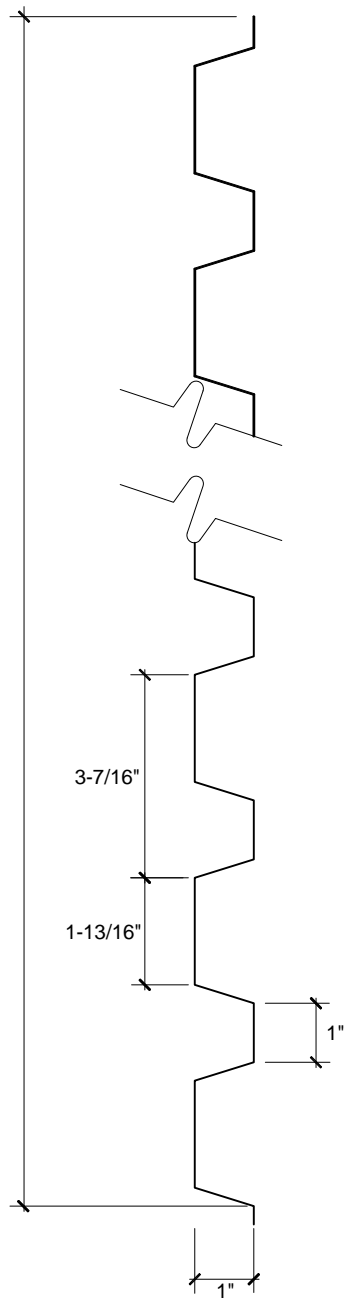

Website: www.rheinzink.com E-mail: info@rheinzink.com

INFORMATION AND DETAILS HEREIN ARE ONLY A BASELINE FOR SYSTEM DESIGN AND INSTALLATION. MODIFICATION TO MEET PROJECT REQUIREMENTS IS THE RESPONSIBILITY OF THE DESIGNER AND ARCHITECT. RHEINZINK AMERICA STAFF ARE AVAILABLE TO ASSIST THE DESIGNER AND ARCHITECT IN THIS PROCESS. RHEINZINK AMERICA MAKES NO REPRESENTATIONS AND WARRANTIES OTHER THAN THOSE EXPRESSED HEREIN.

PROJECT:	TRAPEZOIDAL FACADE - V	DATE:	08-2011
DRAWING TITLE:	PANEL PROFILE	SCALE:	N.T.S.
COPYRIGHT RESERVED. THIS DRAWING REMAINS THE PROPERTY OF RHEINZINK.		SHEET:	TF-V-10